

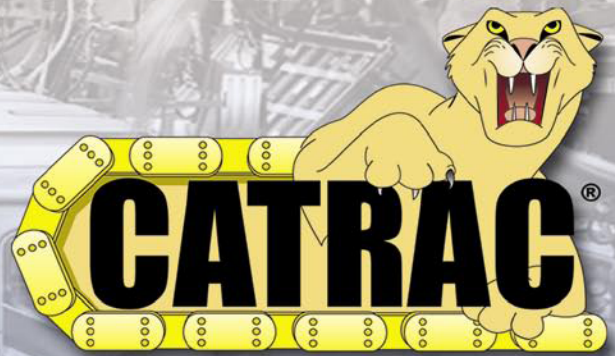

CATRAC® & SnapTrac® Cable & Hose Carrier Products

Ordering Guide & Technical Information



HEAVY DUTY CABLE AND HOSE CARRIERS

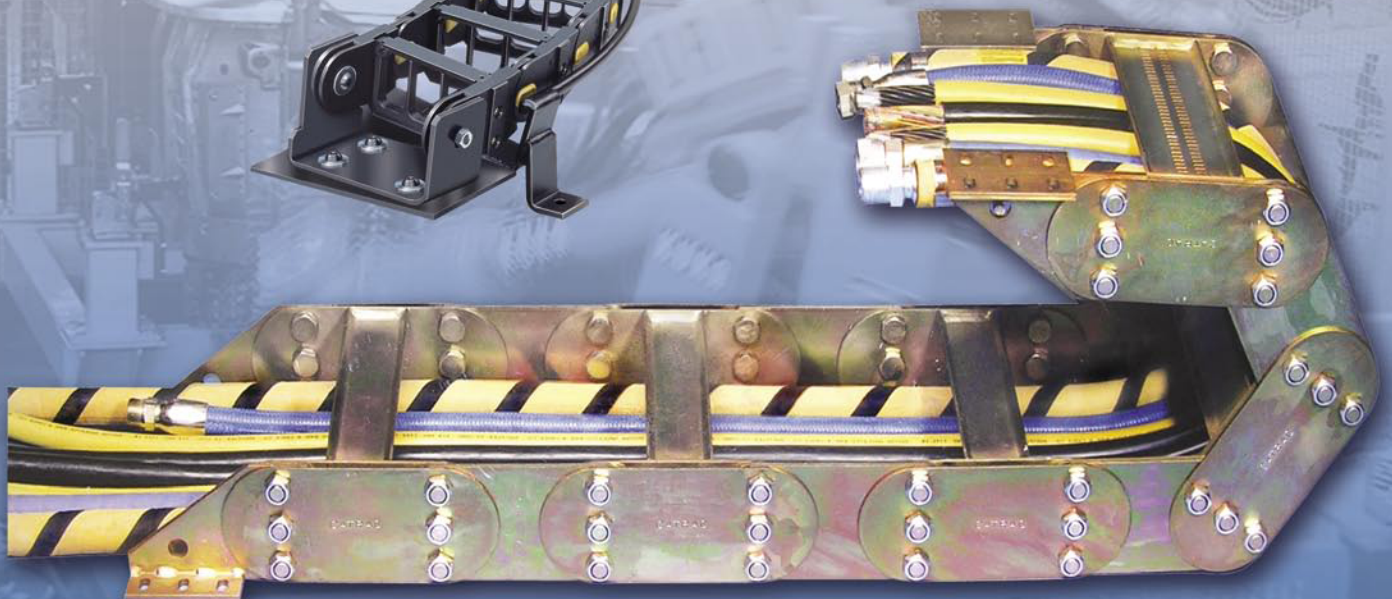



CATRAC® is used on various types of machinery as a means of safely and efficiently conveying power, electrical, air, or fluid (or a combination of these) to equipment in motion. CATRAC is designed to be maintenance free and to protect cables and hoses from abrasion, wear and twisting. A wide variety of options are available.

The center pivot design allows for smoother cycling and minimal hose movement. The CATRAC design offers “No Pinch Points” to insure operator safety. Standard side links are high tensile steel for maximum strength. Steel CATRACs are zinc plated with a yellow dichromate dip for superior corrosion resistance. Optional materials, such as aluminum and stainless steel are available.

We also offer a line of Mill Duty CATRACs that are used in rugged applications and environments such as steel mills. These CATRACs offer a box beam type carrier for maximum strength and stability. Spring loaded rods offer the customer easy access to cables and hoses. They also eliminate the concern of fitting sizes that must pass through the (fixed) compartment opening on a box beam style carrier. Hardened shoulder bolts and locknuts (referred to as bolted construction) are recommended for use in rugged environments. The CATRAC is manufactured so that pieces or sections can be removed or replaced in the field.

Our CATRAC product offers: a variety of sizes from 2.00” to 14.00” high links, carrier options from welded carriers,

split aluminum bar carriers, rod carriers, removable pipe, spring loaded rods, vertical pins, double deck, custom radius “M” dimension (including double radius), custom and special widths, including single widths, double widths, triple widths, etc.. We offer various support systems from a single stationary roller support to a complete CATRAC carriage support system.

We can provide you with the optimum system to suit your needs either with our standard carriers and options or by means of a custom designed system to meet your specific requirements. In addition to our standard systems used in a standard linear motion, we can also provide you with double radius side mounted systems. Contact our applications engineers for additional information or to discuss your needs in detail.

Get on the right track with CATRAC cable & hose carriers.

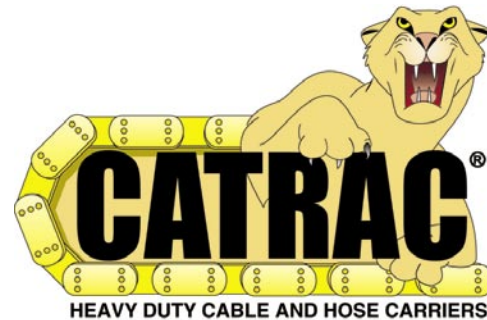

Mounting Variations

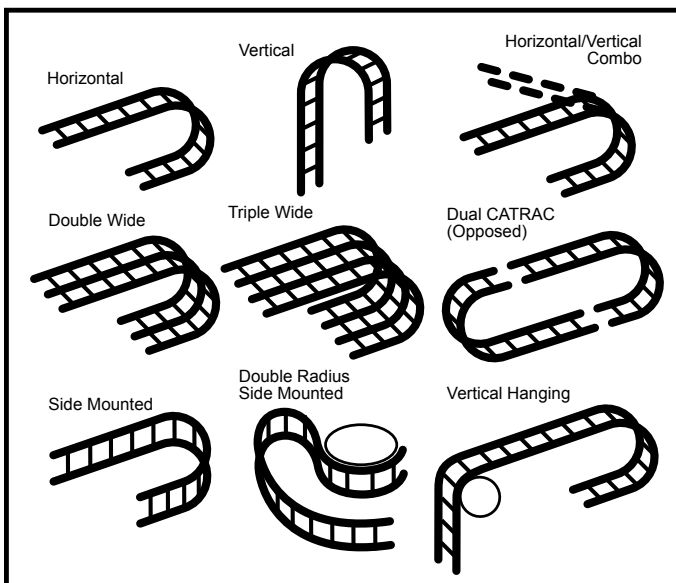

CATRAC® Features

- **No pinch points**
- **Center pivot design for minimal cable and hose wear**
- **Wide variety of standard carrier designs**
- **Available in any radius or width**
- **Custom designs available to optimize your system**
- **Superior finish and corrosion resistance**
- **JIT programs**
- **Short lead times**
- **Designed and manufactured in the USA**

Which CATRAC is right?

1. Determine the outside diameter of the largest cable or hose to be carried.
2. Determine total machine travel. Unsupported length of CATRAC® on horizontal applications is total travel ÷ 2 when no supports are used and the stationary mounting foot is placed at the center line of travel.
3. Determine total weight to be carried per foot.
4. Use the charts to select the proper CATRAC style for your application. Please note that hose area varies with type of carriers used.
5. Determine the rolling radius of the CATRAC by:
 - A) Minimum bend radius of cable or hose recommended by the manufacturer. If this is not available, we recommend a minimum of 6 times the O.D. of the largest cable or hose.
 - B) Space limitations. The "M" dimension of the CATRAC must be less than the available space where track will be installed. The rolling radii shown in the dimension pages are standard. Special radii and "M" dimensions are available to suit your application at no additional cost.
6. Determine CATRAC "X" or inside width. Add the O.D. of all cables and hoses. Allow a minimum of 0.12" between each hose or cable and on both sides of the CATRAC. If vertical separators or hose straps are used, additional clearance is required.
7. Determine the length of the CATRAC. If the mounting foot is placed on the center line of travel as shown on the dimension pages, CATRAC Length = "RL" (radial length) + 1/2 of total travel (T/2). If the mounting foot is placed on either side of center line, the distance from the center line to the mounting foot (Y) must be added.
8. Determine mounting feet requirements and positioning on the CATRAC assembly.

If you need assistance or have any questions on special applications, feel free to contact our application engineers.

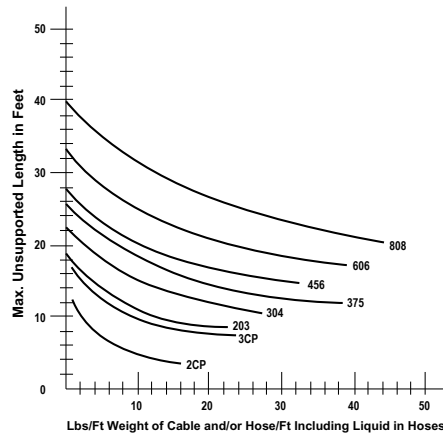
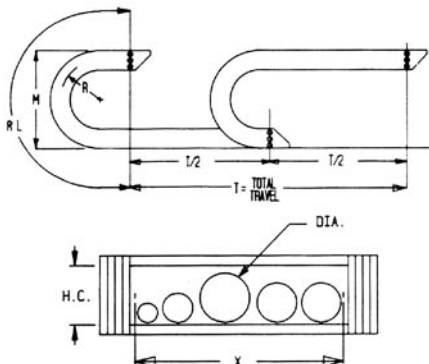

Style	Max. Hose or Cable Clearance	
	RP/RC, SL	WC, AB
203	1.10	1.25
304	1.93	2.00
375	2.67	2.75
456	3.14	3.50
606	4.37	4.50
808	6.00	6.50
2CP	1.18, 1.20	1.25
3CP	1.90	2.00

Consult manufacturer for special carrier designs.

The charts below give conservative estimates of cable and hose O.D. and weight and should be used for quick reference only. Diameters and weights will vary and should be verified with manufacturer.

General Purpose Hose				
Hose Size I.D x O.D.	Braid	Max. PSI	Hose Weight Lbs/Ft	Liquid Weight Lbs/Ft
1/4 x 18/32	2	300	.18	.03
3/8 x 22/32	2	250	.23	.05
1/2 x 22/32	2	250	.29	.09
3/4 x 1 7/32	2	225	.46	.16
1 x 1 1/2	2	225	.64	.34
1 1/4 x 1 25/32	2	225	.70	.53
1 1/2 x 2 1/32	2	225	.80	.77

Small Cable					
16 AWG			14 AWG		
No. Cond.	Dia. in/in/mm	Weight lb/ft kg/m	No. Cond.	Dia. in/in/mm	Weight lb/ft kg/m
2	0.41/10.4	.091/0.14	2	0.53/13.5	.151/0.22
3	0.43/10.9	.112/0.17	3	0.56/14.2	.186/0.26
4	0.49/12.5	.150/0.22	4	0.61/15.5	.221/0.33
5	0.53/13.5	.168/0.25	5	0.62/15.8	.288/0.43
6	0.57/14.5	.195/0.29	6	0.74/18.8	.332/0.49
7	0.61/15.5	.222/0.33	7	0.80/20.3	.362/0.54
8	0.65/16.5	.243/0.36	8	0.85/21.6	.407/0.61
10	0.72/18.3	.306/0.46	10	0.90/22.9	.477/0.71
12	0.74/18.8	.343/0.50	12	0.93/33.6	.529/0.79
16	0.83/21.1	.425/0.63	16	1.08/27.4	.723/1.08
20	0.90/22.9	.512/0.76	20	1.18/30.0	.865/1.29
24	1.02/25.9	.630/0.94	24	1.29/32.8	1.01/1.50
30	1.07/27.2	.745/1.11	30	1.40/35.6	1.25/1.86
36	1.16/29.5	.888/1.32	36	1.51/38.4	1.47/2.19
12 AWG			10 AWG		
No. Cond.	Dia. in/in/mm	Weight lb/ft kg/m	No. Cond.	Dia. in/in/mm	Weight lb/ft kg/m
2	0.61/16.5	.207/0.31	2	0.65/16.5	.243/0.36
3	0.64/16.3	.253/0.38	3	0.70/17.8	.311/0.46
4	0.67/17.0	.297/0.44	4	0.75/19.1	.385/0.57
5	0.73/18.5	.351/0.52	5	0.82/20.8	.461/0.69
6	0.80/20.3	.409/0.61	6	0.88/22.4	.532/0.79
7	0.86/21.8	.472/0.70	7	0.98/24.9	.649/0.97
8	0.92/23.4	.519/0.77	8	1.05/26.7	.717/1.07
10	1.02/25.9	.635/0.95	10	1.13/28.7	.838/1.25
12	1.05/26.7	.706/1.05	12	1.16/29.5	.938/1.40
16	1.16/29.5	.921/1.37	16	1.29/32.8	1.23/1.83
20	1.29/32.8	1.10/1.64	20	1.46/37.1	1.55/2.31
24	1.45/36.8	1.35/2.01	24	1.60/40.6	1.81/2.69
30	1.53/38.9	1.60/2.38			

RC Rod Carriers

Available on 2CP, 3CP, 203, 375, 304 style tracks, this tubing is used to hold the entire CATRAC® together. They are fastened to links with a self tapping screw that can be removed from top or bottom rod to make installation of hose or cable easier.



WC Welded Carriers

The carrier is widely used in very rugged applications. It can withstand severe hydraulic shock and has no loose parts which can be lost during installation of the hose cable. The welded carrier bars alternate position top to bottom on styles 203, 375 and 304. Styles 456, 606 and 808 use a box beam construction with top and bottom beams across from each other for added strength.



RP Removable Pipe (Standard)

This assembly provides easy installation of cable and hose. The pipe can be removed by knocking out a roll pin and pulling it out the side of the CATRAC.



SL Spring Loaded Removable Pipe

This design provides the quickest way to install or change cable and hose in the field. Simply compress the plunger and pull the pipe out. No screws or pins need to be removed and no side space limitations need to be considered.



AB Split Bar Carriers

1/2" wide aluminum or 3/4" wide wood split bar carriers can be provided. This carrier is custom machined to your specifications. Note: Holes must be at least 1/8" larger than cable hose diameter.



VP Vertical Pins

Vertical pins, also referred to as separators or dividers, can be welded into RP, SL and WC style carriers to separate cables or hoses to prevent twisting or overlap.



Extra Heavy Duty (Mill-Duty) Construction

For steel mills and other heavy duty service, the double welded carrier (MD option) is used as well as bolted construction (BC option). This structure has the ultimate strength for a carrier. Box beam construction is standard in the 456, 606, and 808 styles and can withstand severe hydraulic shock loads.



Optional & Special Carrier Designs

Special perforated carriers can be supplied which provide openings for hose straps. The hose straps, if used, should be very loose and used as a hose and cable separator rather than a tie down.

Many carriers and stiffeners are designed in cooperation with our customers. We welcome ideas to fit your specific application needs.

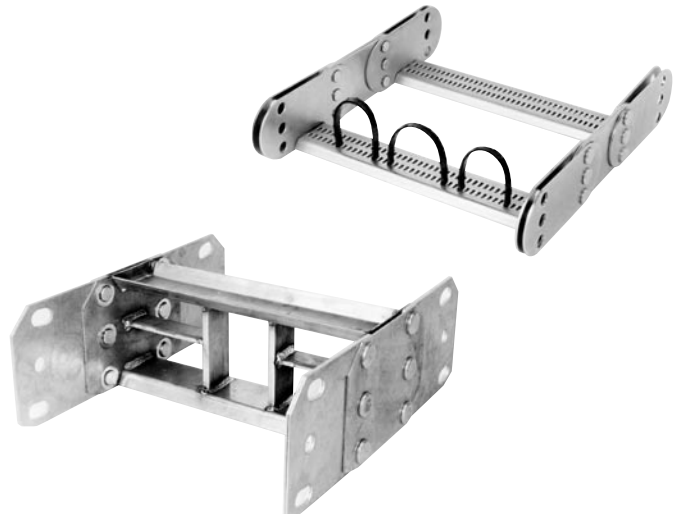



2CP and 3CP CATRAC® Part Number System

8060

CATRAC

2CP

2.75

04

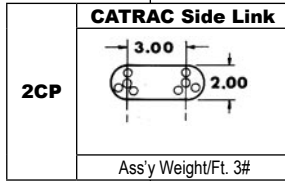

2CP	Radius "R"	Overall Height "M"
	2.75	7.50
	4.75	11.50
	5.63	13.25

2CP	Carrier Width*
	02
	04
	06
	08

*Consult factory for special radius.

*Consult factory for special widths.

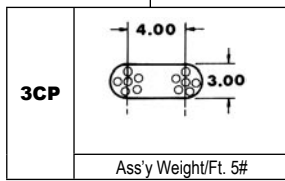

3CP	5.13	13.25
	6.63	16.25
	8.19	19.38
	10.90	24.80
	15.13	33.25

3CP	04
	06
	08
	10
	12

Weight based on 8" carrier.

NOTE: Mounting feet must be ordered separately by the pair. All dimensions are in inches.

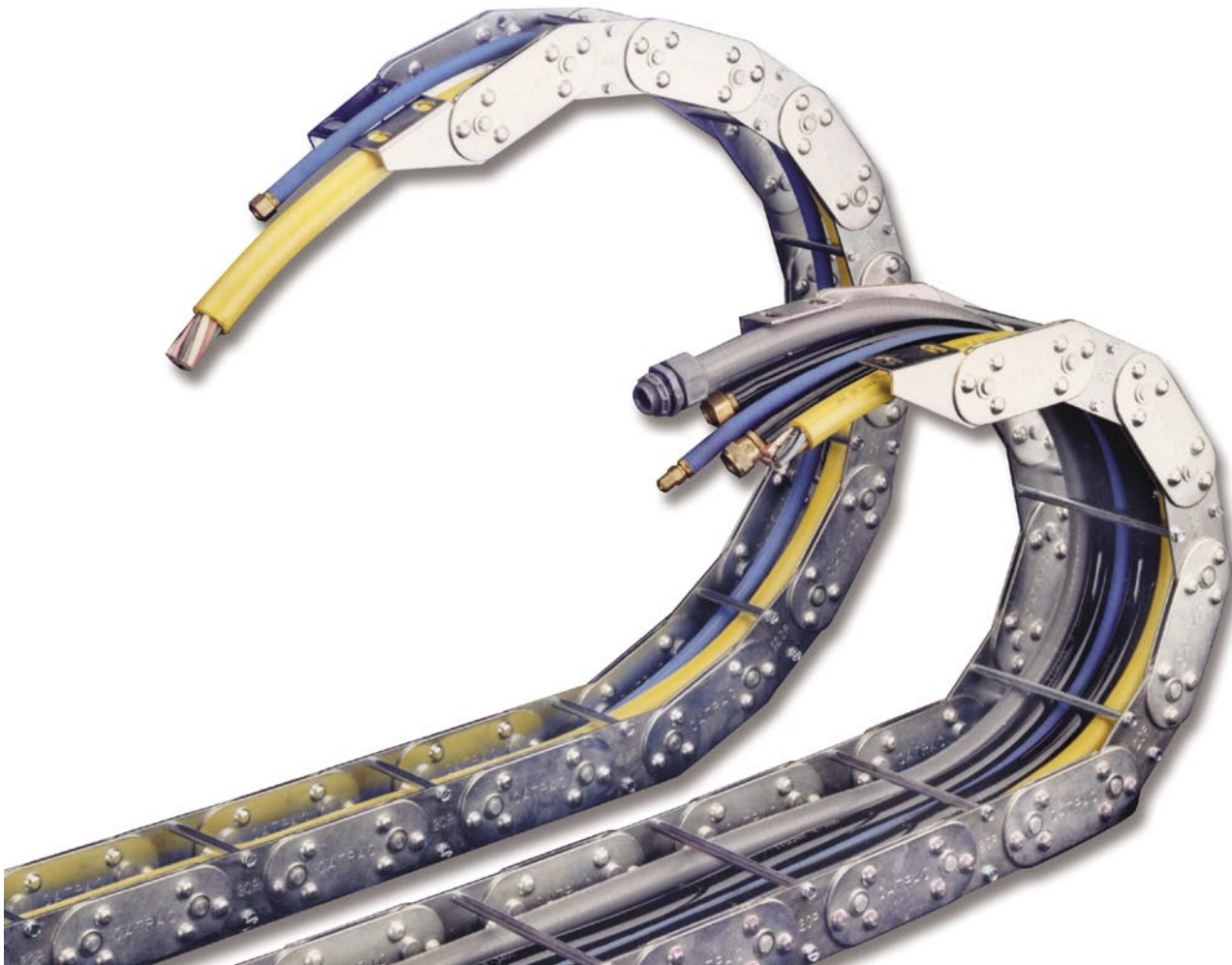

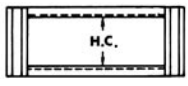
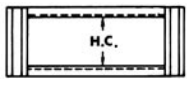

2CP and 3CP CATRAC® Part Number System

WC		Welded Carrier		
		Style	HC	
WC		2CP	1.25	
		3CP	2.00	

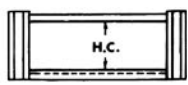
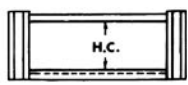
SL		Spring Loaded Removable Pipe		
		Style	HC	
SL		2CP	1.20	
		3CP	1.90	

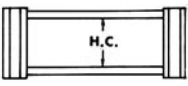
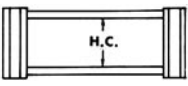
RC		Rod Carrier		
		Style	HC	
RC		2CP	1.18	
		3CP	1.90	

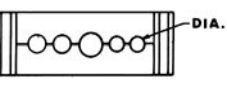
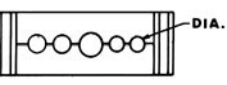
AB		Split Aluminum Bar Carrier		
		Style	Max. DIA.	
AB		2CP	1.25	
		3CP	2.00	

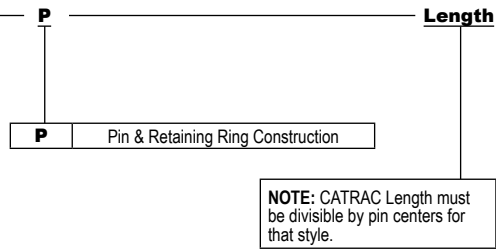

Standard Mounting Feet			
CATRAC Style	Horiz. Mount Feet P/N	Vert. Mount Feet P/N	Req'd per CATRAC
2CP	PC-0126000-B	PC-0127900-B	2 Pair
3CP	PC-0128000-B	PC-0128100-B	2 Pair

Normally one (1) pair of mounting feet are used at each end of the CATRAC. Unless specified, flanges are mounted inward on standard CATRAC.

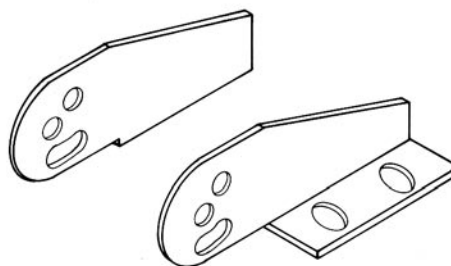

Horizontal Mounting Feet

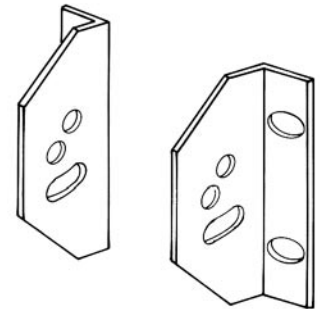

Vertical Mounting Feet



CATRAC[®] 2CP Dimensions

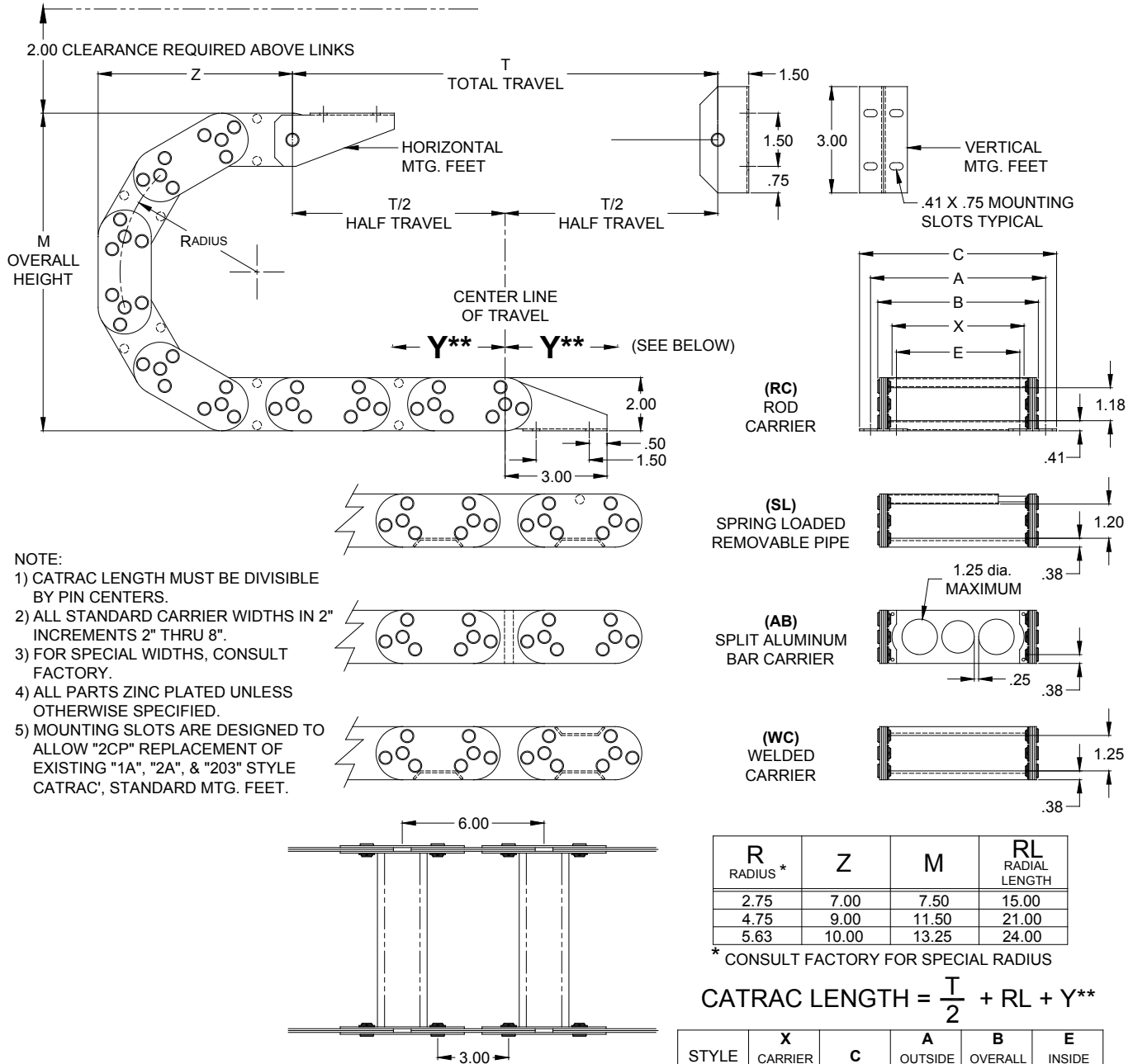

- NOTE:
- 1) CATRAC LENGTH MUST BE DIVISIBLE BY PIN CENTERS.
 - 2) ALL STANDARD CARRIER WIDTHS IN 2" INCREMENTS 2" THRU 8".
 - 3) FOR SPECIAL WIDTHS, CONSULT FACTORY.
 - 4) ALL PARTS ZINC PLATED UNLESS OTHERWISE SPECIFIED.
 - 5) MOUNTING SLOTS ARE DESIGNED TO ALLOW "2CP" REPLACEMENT OF EXISTING "1A", "2A", & "203" STYLE CATRAC, STANDARD MTG. FEET.

R RADIUS *	Z	M	RL RADIAL LENGTH
2.75	7.00	7.50	15.00
4.75	9.00	11.50	21.00
5.63	10.00	13.25	24.00

* CONSULT FACTORY FOR SPECIAL RADIUS

$$\text{CATRAC LENGTH} = \frac{T}{2} + RL + Y^{**}$$

STYLE	X CARRIER WIDTH	C	A OUTSIDE MTG.	B OVERALL	E INSIDE MTG.
2CP	4.00	7.32	6.07	5.50	3.54
	X	X + 3.32	X + 2.07	X + 1.50	X - .48

** IF THE STATIONARY FOOT IS MOUNTED ON EITHER SIDE OF THE CENTER LINE OF TRAVEL, THE DISTANCE (Y) BETWEEN CENTER LINE AND STATIONARY FOOT MUST BE ADDED TO CATRAC LENGTH.



CATRAC® 3CP Dimensions

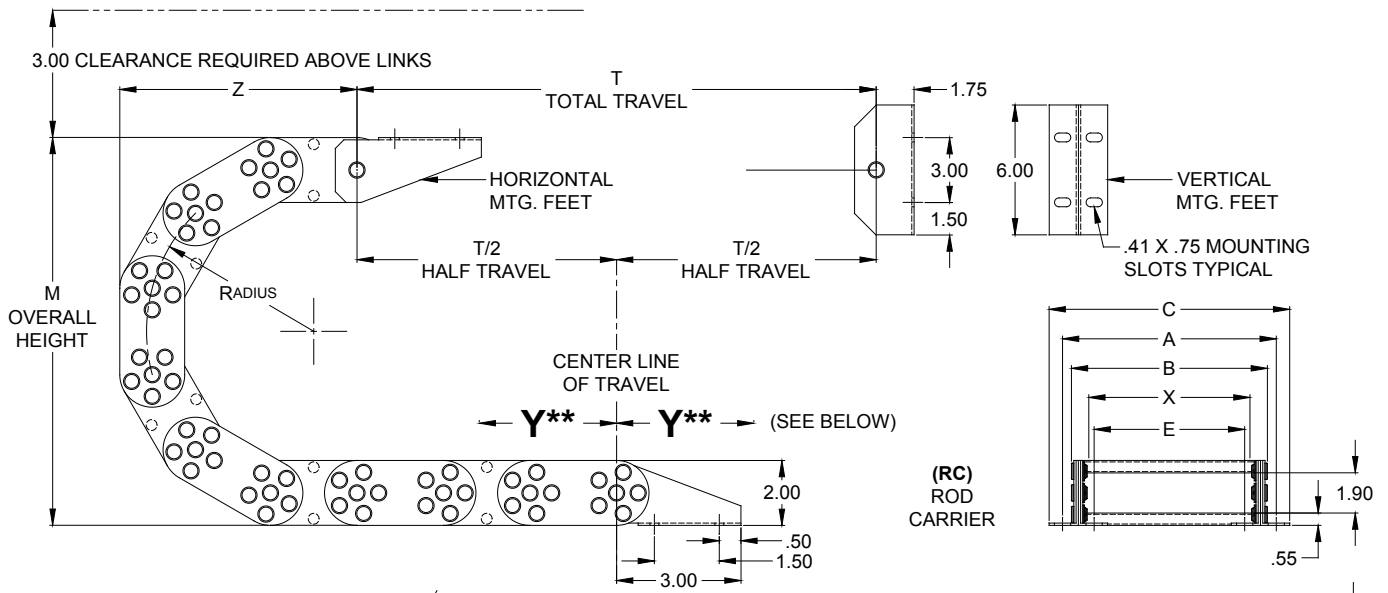

- NOTE:
- 1) CATRAC LENGTH MUST BE DIVISIBLE BY PIN CENTERS.
 - 2) ALL STANDARD CARRIER WIDTHS IN 2" INCREMENTS 4" THRU 12".
 - 3) FOR SPECIAL WIDTHS, CONSULT FACTORY.
 - 4) ALL PARTS ZINC PLATED UNLESS OTHERWISE SPECIFIED.
 - 5) MOUNTING SLOTS ARE DESIGNED TO ALLOW "3CP" REPLACEMENT OF EXISTING "BB", "CC", & "304" STYLE CATRAC'S, STANDARD MTG. FEET.

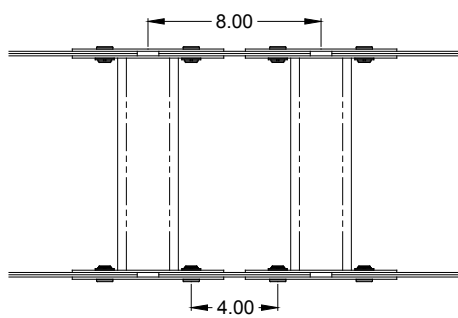
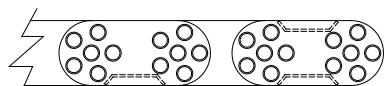
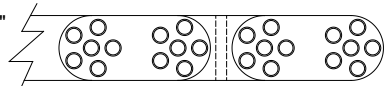
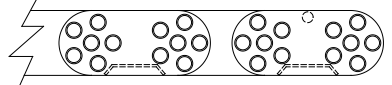

(RC)
ROD
CARRIER

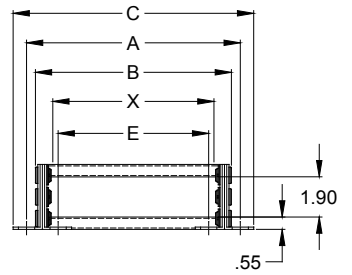

(SL)
SPRING LOADED
REMOVABLE PIPE

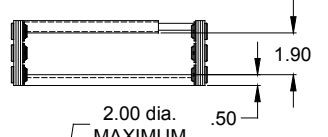

(AB)
SPLIT ALUMINUM
BAR CARRIER

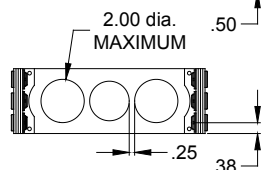

(WC)
WELDED
CARRIER

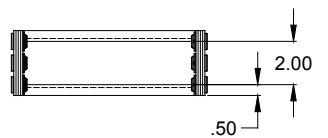

R RADIUS *	Z	M	RL RADIAL LENGTH
5.13	10.57	13.25	24.00
6.63	13.72	16.25	32.00
8.19	14.83	19.38	36.00
10.90	17.28	24.80	44.00
15.13	20.87	33.25	56.00

* CONSULT FACTORY FOR SPECIAL RADIUS

$$\text{CATRAC LENGTH} = \frac{T}{2} + \text{RL} + Y^{**}$$

** IF THE STATIONARY FOOT IS MOUNTED ON EITHER SIDE OF THE CENTER LINE OF TRAVEL, THE DISTANCE (Y) BETWEEN CENTER LINE AND STATIONARY FOOT MUST BE ADDED TO CATRAC LENGTH.

STYLE	X CARRIER WIDTH	C	A OUTSIDE MTG.	B OVERALL	E INSIDE MTG.
3CP	4.00	7.32	6.21	5.50	3.38
	X	X + 3.32	X + 2.21	X + 1.50	X - .62



Mill-Duty CATRAC® Part Number System

8060
CATRAC

203

2.75

4

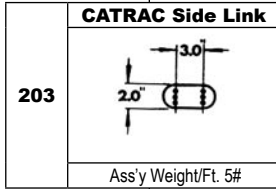

203	Radius "R"	Overall Height "M"
	2.75	7.50
	4.75	11.50
	5.63	13.25
	8.69	19.38

203	Carrier Width
	4
	6
	8
	10
	12

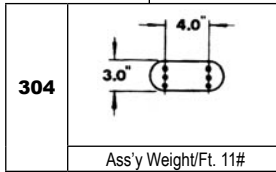

304	5.13	13.25
	6.63	16.25
	8.19	19.38
	10.90	24.80
	15.13	33.25

304	4
	6
	8
	10
	12
	14
	16
	18

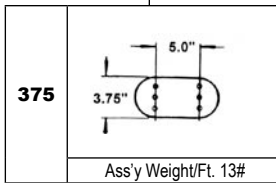

375	5.62	15.00
	7.37	18.50
	11.12	26.00
	14.87	33.50
	24.12	52.00

375	4
	6
	8
	10
	12
	14
	16
	18

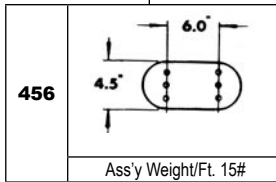

456	5.88	16.25
	7.44	19.38
	10.15	24.80
	14.38	33.25
	21.25	47.00

456	4
	6
	8
	10
	12
	14
	16
	18
20	

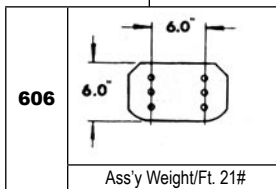

606	11.00	28.00
	14.81	35.62
	20.50	47.00
	24.12	54.25

606	6
	8
	10
	12
	14
	16
	18
20	

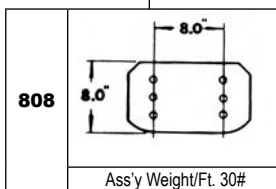

808	10.50	29.00
	12.50	33.00
	19.50	47.00
	23.12	54.25

808	8
	10
	12
	14
	16
	18
	20
	22
24	

Weight based on 8" carrier.



Mill-Duty CATRAC® Part Number System

WC

Welded Carrier		
Style	HC	
203	1.25	
304	2.00	
375	2.75	
456	3.50	
606	4.50	
808	6.50	

WC

Spring Loaded Removable Pipe		
Style	HC	
203	1.10	
304	1.93	
375	2.67	
456	3.14	
606	4.37	
808	6.00	

SL

Removable Pipe		
Style	HC	
203	1.10	
304	1.93	
375	2.67	
456	3.14	
606	4.37	
808	6.00	

RP

Split Aluminum Bar Carrier		
Style	Max. Hole	
203	1.25	
304	2.00	
375	2.75	
456	3.50	
606	4.50	
808	6.50	

AB

VP

Welded Vertical Pins On Carrier Types RP, SL & WC	
No Charge	
	Quantity & Location Per Customer

VP

X	No Vertical Pins
----------	------------------

BC

X	Snap Ring Const.
BC	Bolted 203
	Bolted 304
	Bolted 375
	Bolted 456
	Bolted 606
	Bolted 808

Length

Note: CATRAC Length must be divisible by pin centers for that style.

Standard Mounting Feet			
CATRAC Style	Horiz. Mount Feet P/N	Vert. Mount Feet P/N	Req'd per CATRAC
203	PC-0089000-B	PC-0089200-B	2 Pair
304	PC-0091000-B	PC-0091200-B	2 Pair
375	PC-0191900-B	PC-0192000-B	2 Pair
456	PC-0093000-B	PC-0093200-B	2 Pair
606	PC-0095000-B	PC-0095200-B	4 Pair
808	PC-0097000-B	PC-0097200-B	4 Pair

Vertical Mounting Feet

Normally one (1) pair of mounting feet are used at each end of the CATRAC. Unless specified, flanges are mounted inward on standard CATRAC.

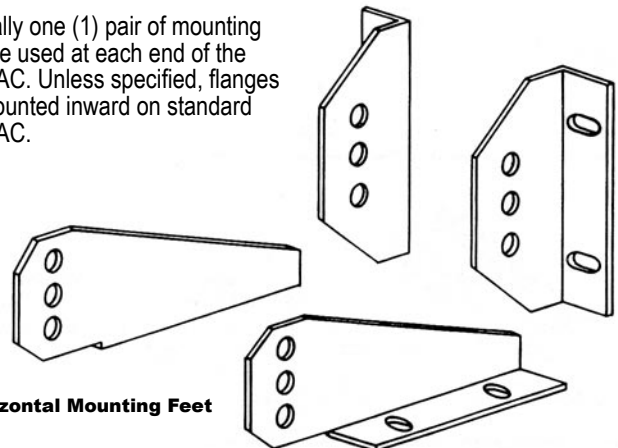

Horizontal Mounting Feet



CATRAC® 304 Dimensions

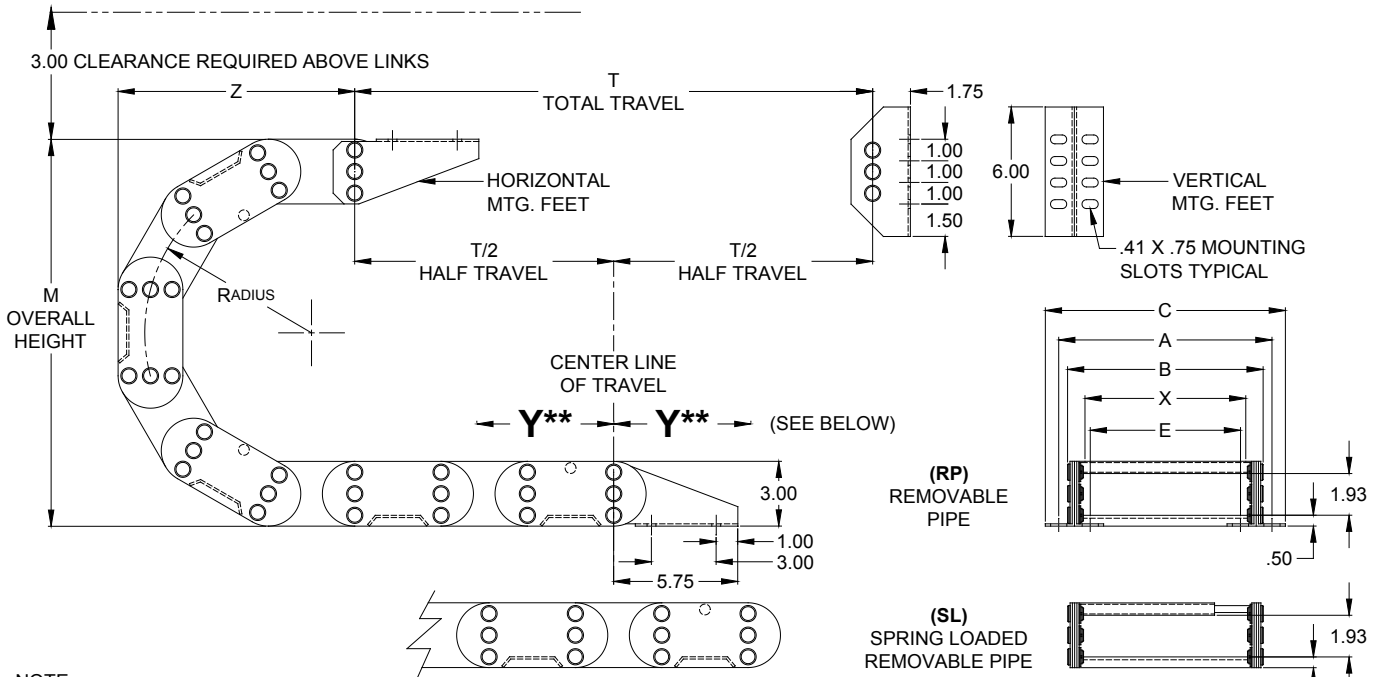

- NOTE:
- 1) CATRAC LENGTH MUST BE DIVISIBLE BY PIN CENTERS.
 - 2) ALL STANDARD CARRIER WIDTHS IN 2" INCREMENTS 4" THRU 18".
 - 3) FOR MULTIPLE OR SPECIAL WIDTHS, CONSULT FACTORY.
 - 4) ALL PARTS ZINC PLATED UNLESS OTHERWISE SPECIFIED.

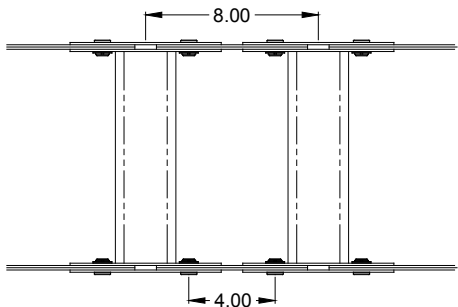

R RADIUS *	Z	M	RL RADIAL LENGTH
5.13	10.57	13.25	24.00
6.63	13.72	16.25	32.00
8.19	14.83	19.38	36.00
10.90	17.28	24.80	44.00
15.13	20.87	33.25	56.00

* CONSULT FACTORY FOR SPECIAL RADIUS

$$\text{CATRAC LENGTH} = \frac{T}{2} + \text{RL} + Y^{**}$$

STYLE	X CARRIER WIDTH	C	A OUTSIDE MTG.	B OVERALL	E INSIDE MTG.
304 PIN	4.00	7.88	6.55	5.79	3.38
	X	X + 3.88	X + 2.55	X + 1.79	X - .62
304 BOLTED	4.00	7.88	6.55	6.29	3.38
	X	X + 3.88	X + 2.55	X + 2.29	X - .62

** IF THE STATIONARY FOOT IS MOUNTED ON EITHER SIDE OF THE CENTER LINE OF TRAVEL, THE DISTANCE (Y) BETWEEN CENTER LINE AND STATIONARY FOOT MUST BE ADDED TO CATRAC LENGTH.



CATRAC® 375 Dimensions

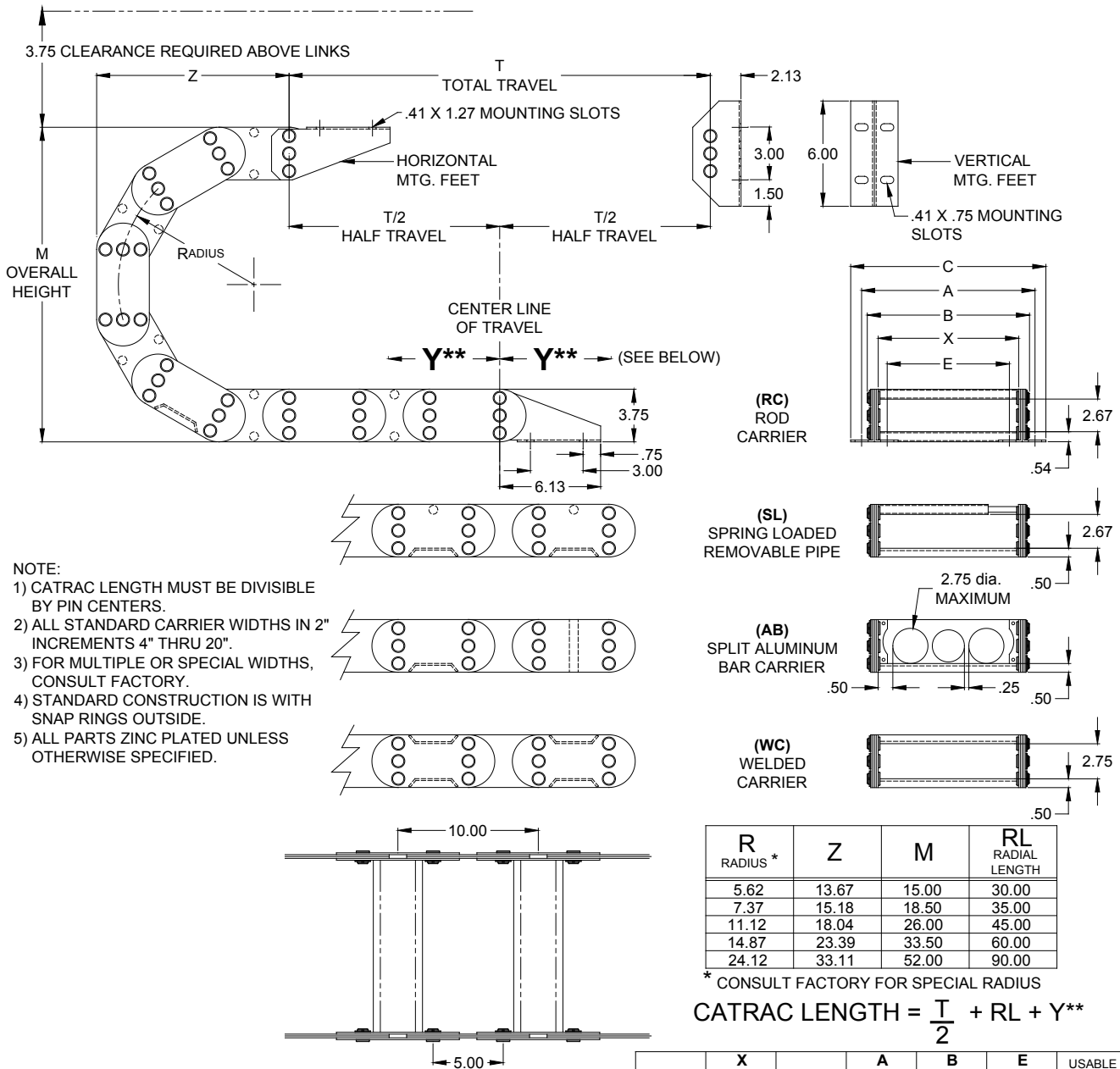

NOTE:

- 1) CATRAC LENGTH MUST BE DIVISIBLE BY PIN CENTERS.
- 2) ALL STANDARD CARRIER WIDTHS IN 2" INCREMENTS 4" THRU 20".
- 3) FOR MULTIPLE OR SPECIAL WIDTHS, CONSULT FACTORY.
- 4) STANDARD CONSTRUCTION IS WITH SNAP RINGS OUTSIDE.
- 5) ALL PARTS ZINC PLATED UNLESS OTHERWISE SPECIFIED.

R RADIUS *	Z	M	RL RADIAL LENGTH
5.62	13.67	15.00	30.00
7.37	15.18	18.50	35.00
11.12	18.04	26.00	45.00
14.87	23.39	33.50	60.00
24.12	33.11	52.00	90.00

* CONSULT FACTORY FOR SPECIAL RADIUS

$$\text{CATRAC LENGTH} = \frac{T}{2} + \text{RL} + Y^{**}$$

STYLE	X CARRIER WIDTH	C	A OUTSIDE MTG.	B OVERALL	E INSIDE MTG.	USABLE INSIDE WIDTH
375 PIN	4.00	8.11	6.31	5.22	2.32	3.78
	X	X + 4.11	X + 2.31	X + 1.22	X - 1.68	X - .22
375 BOLTED	4.00	8.11	6.31	5.88	2.32	3.78
	X	X + 4.11	X + 2.31	X + 1.88	X - 1.68	X - .22

****** IF THE STATIONARY FOOT IS MOUNTED ON EITHER SIDE OF THE CENTER LINE OF TRAVEL, THE DISTANCE (Y) BETWEEN CENTER LINE AND STATIONARY FOOT MUST BE ADDED TO CATRAC LENGTH.

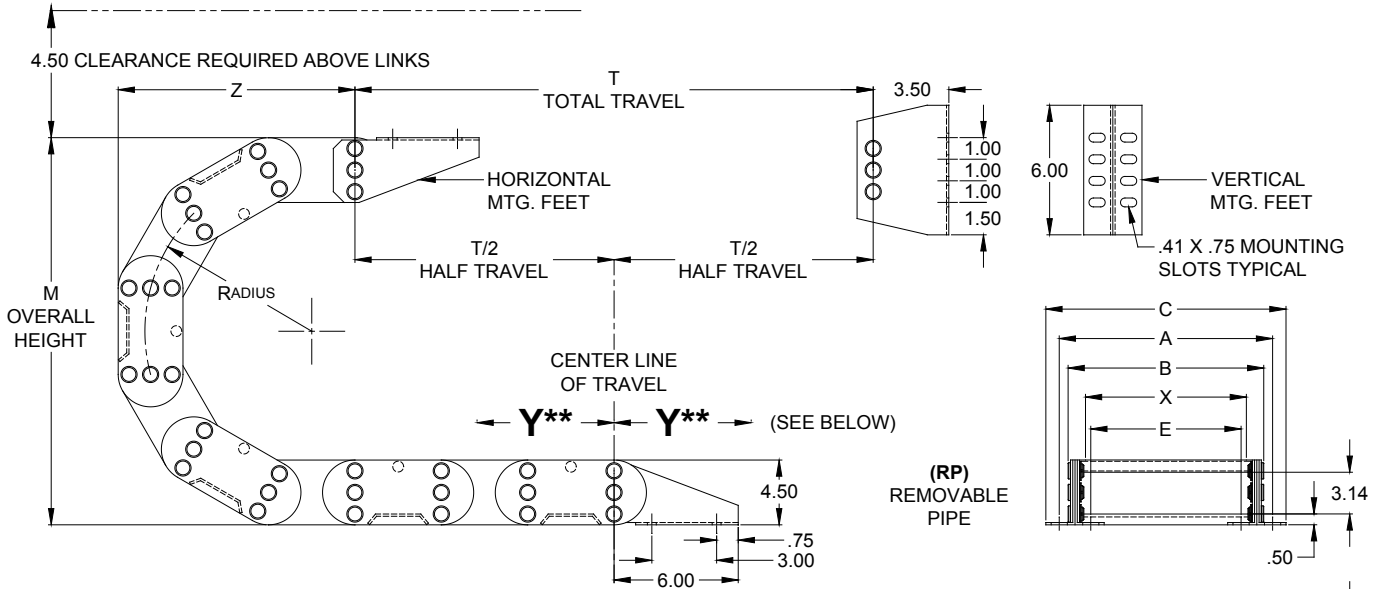

NOTE:

- 1) CATRAC LENGTH MUST BE DIVISIBLE BY PIN CENTERS.
- 2) ALL STANDARD CARRIER WIDTHS IN 2" INCREMENTS 4" THRU 20".
- 3) FOR MULTIPLE OR SPECIAL WIDTHS, CONSULT FACTORY.
- 4) ALL PARTS ZINC PLATED UNLESS OTHERWISE SPECIFIED.

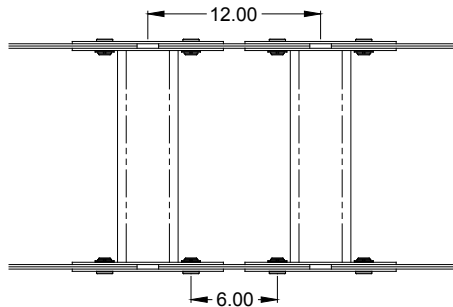
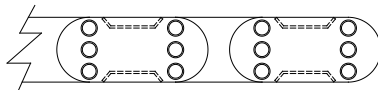
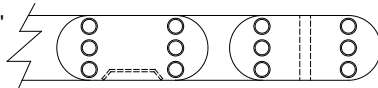
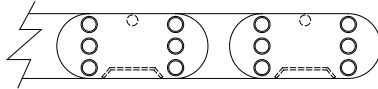

(RP)
REMOVABLE
PIPE

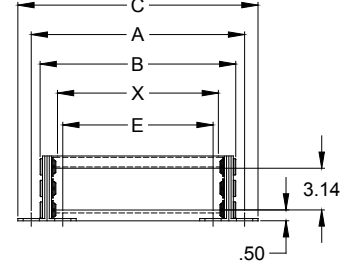

(SL)
SPRING LOADED
REMOVABLE PIPE

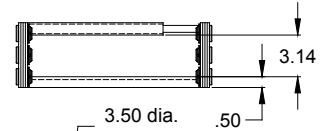

(AB)
SPLIT ALUMINUM
BAR CARRIER

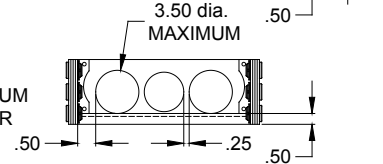

(WC)
WELDED
CARRIER

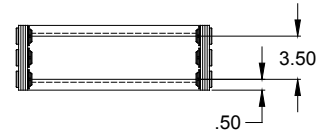

R RADIUS *	Z	M	RL RADIAL LENGTH
5.88	14.00	16.25	30.00
7.44	16.00	19.38	36.00
10.15	20.50	24.80	48.00
14.38	24.00	33.25	60.00
21.25	32.00	47.00	84.00

* CONSULT FACTORY FOR SPECIAL RADIUS

$$\text{CATRAC LENGTH} = \frac{T}{2} + \text{RL} + Y^{**}$$

STYLE	X CARRIER WIDTH	C	A OUTSIDE MTG.	B OVERALL	E INSIDE MTG.
456 PIN	4.00	8.13	6.75	6.03	3.42
	X	X + 4.13	X + 2.75	X + 2.03	X - .58
456 BOLTED	4.00	8.13	6.75	6.53	3.42
	X	X + 4.13	X + 2.75	X + 2.53	X - .58

****** IF THE STATIONARY FOOT IS MOUNTED ON EITHER SIDE OF THE CENTER LINE OF TRAVEL, THE DISTANCE (Y) BETWEEN CENTER LINE AND STATIONARY FOOT MUST BE ADDED TO CATRAC LENGTH.



CATRAC® 606 Dimensions

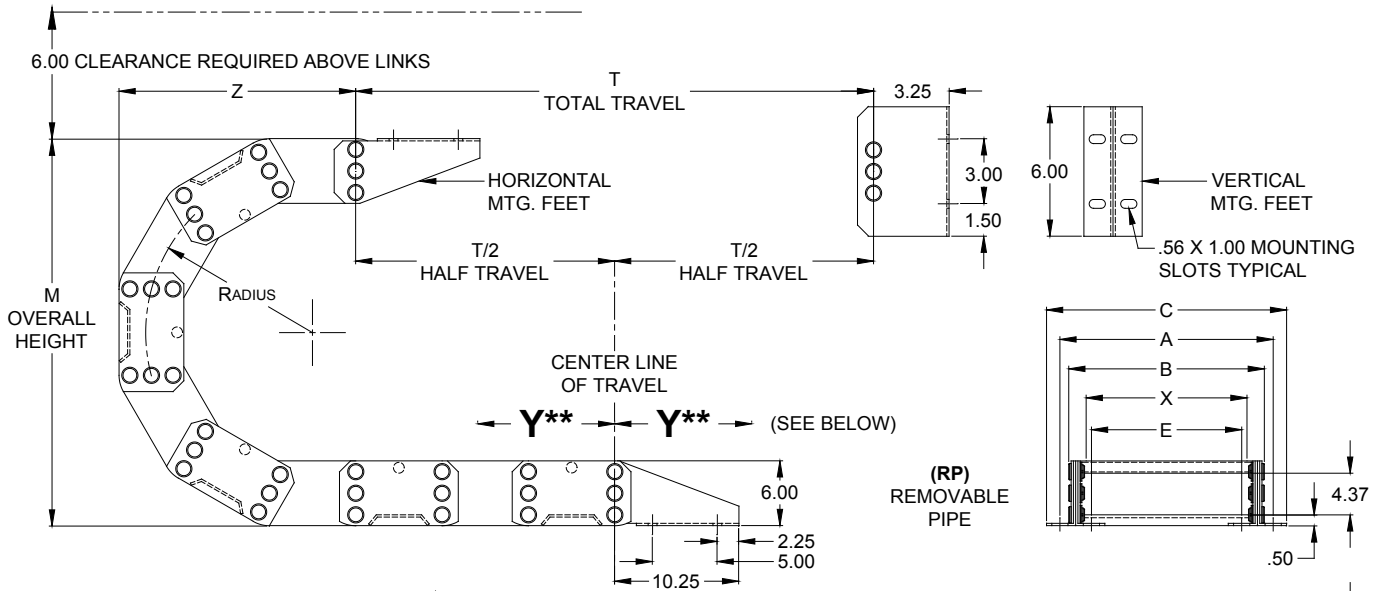

NOTE:

- 1) CATRAC LENGTH MUST BE DIVISIBLE BY PIN CENTERS.
- 2) ALL STANDARD CARRIER WIDTHS IN 2" INCREMENTS 6" THRU 20".
- 3) FOR MULTIPLE OR SPECIAL WIDTHS, CONSULT FACTORY.
- 4) ALL PARTS ZINC PLATED UNLESS OTHERWISE SPECIFIED.

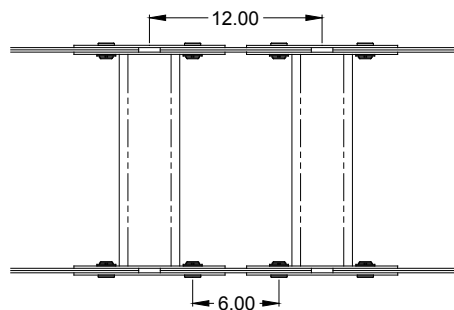
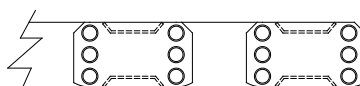
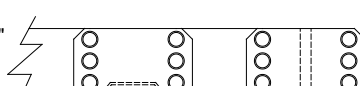
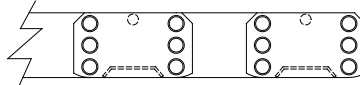

(RP)
REMOVABLE
PIPE

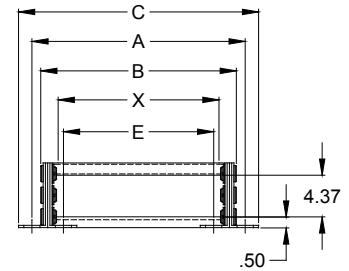

(SL)
SPRING LOADED
REMOVABLE PIPE

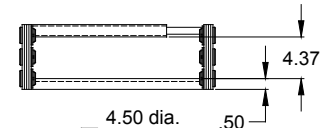

(AB)
SPLIT ALUMINUM
BAR CARRIER

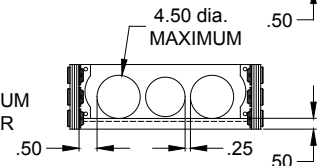

(WC)
WELDED
CARRIER

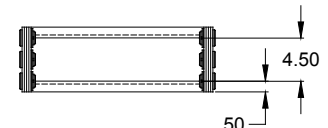

R RADIUS *	Z	M	RL RADIAL LENGTH
11.00	20.72	28.00	48.00
14.81	24.55	35.62	60.00
20.50	30.30	47.00	78.00
24.12	34.24	54.25	90.00

* CONSULT FACTORY FOR SPECIAL RADIUS

$$\text{CATRAC LENGTH} = \frac{T}{2} + \text{RL} + Y^{**}$$

STYLE	X CARRIER WIDTH	C	A OUTSIDE MTG.	B OVERALL	E INSIDE MTG.
606 PIN	6.00	10.63	9.00	8.03	5.18
	X	X + 4.63	X + 3.00	X + 2.03	X - .82
606 BOLTED	6.00	10.63	9.00	8.63	5.18
	X	X + 4.63	X + 3.00	X + 2.63	X - .82

** IF THE STATIONARY FOOT IS MOUNTED ON EITHER SIDE OF THE CENTER LINE OF TRAVEL, THE DISTANCE (Y) BETWEEN CENTER LINE AND STATIONARY FOOT MUST BE ADDED TO CATRAC LENGTH.



CATRAC® 808 Dimensions

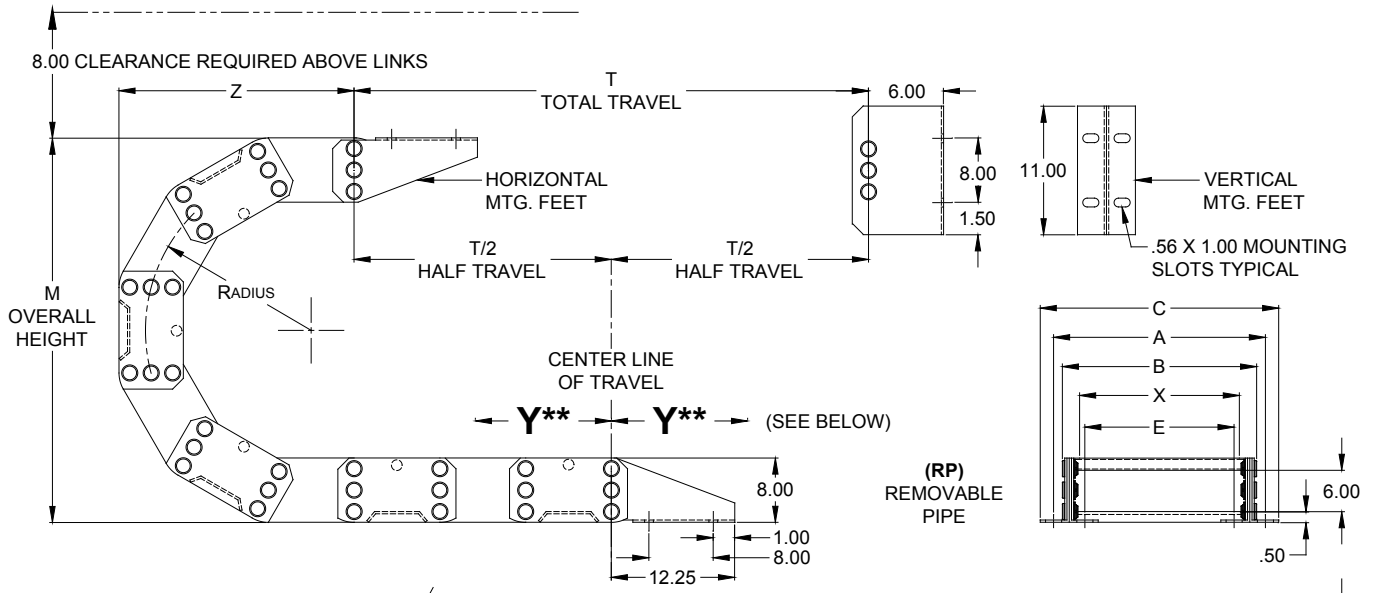

NOTE:

- 1) CATRAC LENGTH MUST BE DIVISIBLE BY PIN CENTERS.
- 2) ALL STANDARD CARRIER WIDTHS IN 2" INCREMENTS 8" THRU 24".
- 3) FOR MULTIPLE OR SPECIAL WIDTHS, CONSULT FACTORY.
- 4) ALL PARTS ZINC PLATED UNLESS OTHERWISE SPECIFIED.

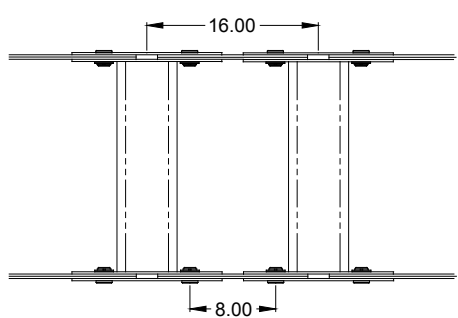
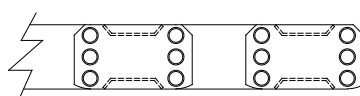
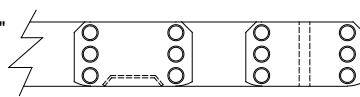
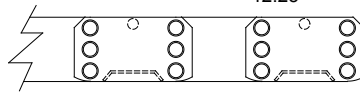

(RP)
REMOVABLE
PIPE

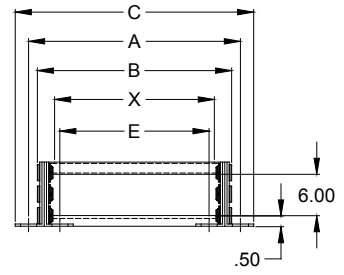

(SL)
SPRING LOADED
REMOVABLE PIPE

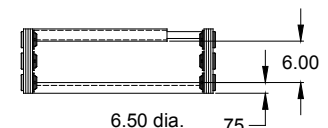

(AB)
SPLIT ALUMINUM
BAR CARRIER

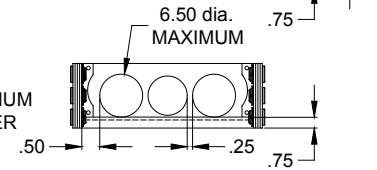

(WC)
WELDED
CARRIER

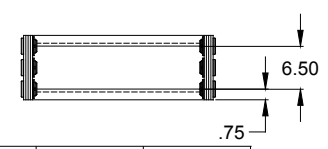

R RADIUS *	Z	M	RL RADIAL LENGTH
10.50	22.00	29.00	48.00
12.50	24.87	33.00	56.00
19.50	32.87	47.00	80.00
23.12	34.80	54.25	88.00

* CONSULT FACTORY FOR SPECIAL RADIUS

$$\text{CATRAC LENGTH} = \frac{T}{2} + \text{RL} + Y^{**}$$

STYLE	X CARRIER WIDTH	C	A OUTSIDE MTG.	B OVERALL	E INSIDE MTG.
808 PIN	8.00	12.63	11.00	10.03	7.18
	X	X + 4.63	X + 3.00	X + 2.03	X - .82
808 BOLTED	8.00	12.63	11.00	10.63	7.18
	X	X + 4.63	X + 3.00	X + 2.63	X - .82

****** IF THE STATIONARY FOOT IS MOUNTED ON EITHER SIDE OF THE CENTER LINE OF TRAVEL, THE DISTANCE (Y) BETWEEN CENTER LINE AND STATIONARY FOOT MUST BE ADDED TO CATRAC LENGTH.

Stationary Roller Support	CATRAC Style	Radius	B Dim.	Carrier Width
PD-486	203	5.63	11.25	4
		8.69	17.38	
304	5.63	5.13	10.25	4
		6.63	13.25	
		8.19	16.38	
		10.90	21.80	
		15.13	30.25	
375	5.63	5.62	11.25	4
		7.37	14.75	
		11.12	22.25	
		14.87	29.75	
		24.12	48.25	
456	5.63	5.88	11.75	4
		7.44	14.88	
		10.15	20.30	
		14.38	28.75	
		21.25	42.50	
606	5.63	11.00	22.00	4
		14.81	29.62	
		20.50	41.00	
		24.12	48.25	
808	5.63	10.50	21.00	4
		12.50	25.00	
		19.50	39.00	
		23.12	46.25	

CATRAC® with roller support systems

The roller supports provide a means of maintaining the maximum unsupported length while increasing the total travel. There are four methods of extending the total travel:

1. Utilize a CATRAC with a high side link which provides a greater unsupported length.
2. Utilize stationary roller supports.
3. Utilize a combination of stationary and retractable roller supports.
4. Utilize a carriage support system.

Consult factory for carrier widths and radii not shown.

203, 304, 456, 606, 808 Styles of CATRAC*		
Carrier Width	A Dim.	C Dim.
4.00	13.52	11.52
x	x + 9.52	x + 7.52
Nuts Out	x + 10.02	x + 8.02

*375 Style Consult Factory.
 Note: Approximate dimensions, not for construction unless certified.
 All dimensions in inches unless otherwise specified.

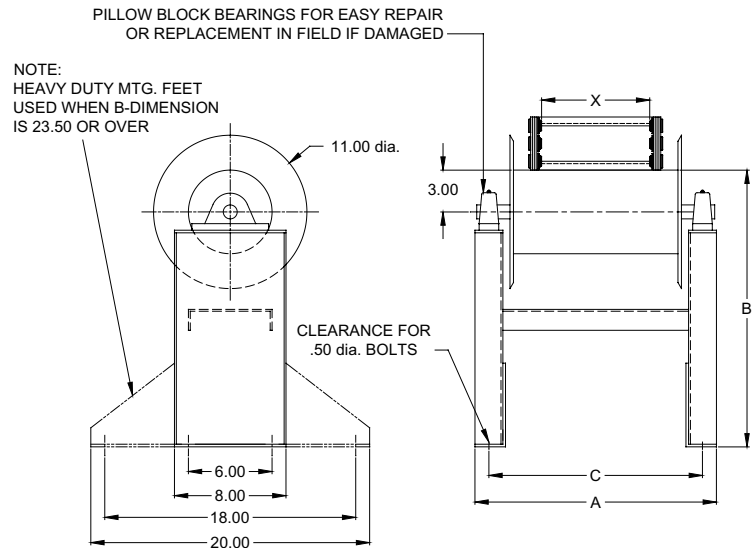

T = TOTAL TRAVEL
 UL = MAXIMUM UNSUPPORTED LENGTH

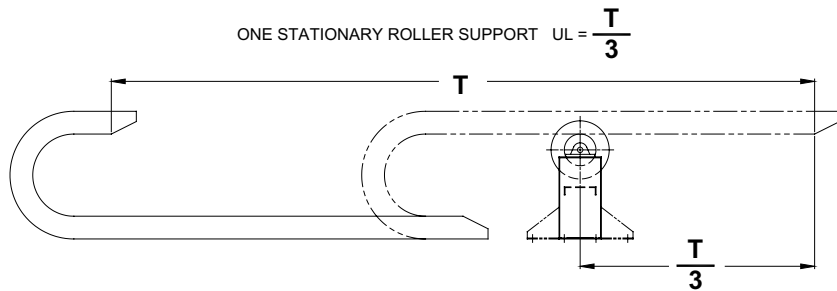
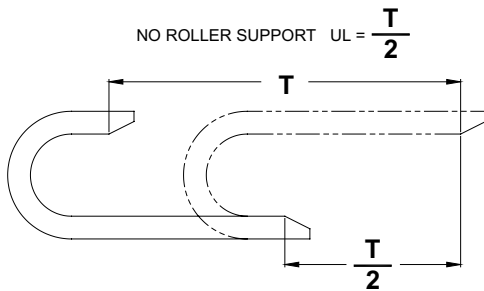



Retractable Roller Part Number System

PD-1218

304

5.13

8

Retractable Roller Support

CATRAC Style 304

Radius	B Dim.
5.13	11.13
6.63	14.13
8.19	17.26
10.90	22.68
15.13	31.13

Carrier Width
8
10
12
14
16
18
20

For radii not shown and for multiple carrier widths, consult factory.

375

5.62	12.13
7.37	15.63
11.12	23.13
14.87	30.63
24.12	49.13

456

5.88	12.63
7.44	15.76
10.15	21.18
14.38	29.63
21.25	43.38

606

11.00	22.88
14.81	30.50
20.50	41.88
24.12	49.13

808

10.50	21.88
12.50	25.88
19.50	39.88
23.12	47.13

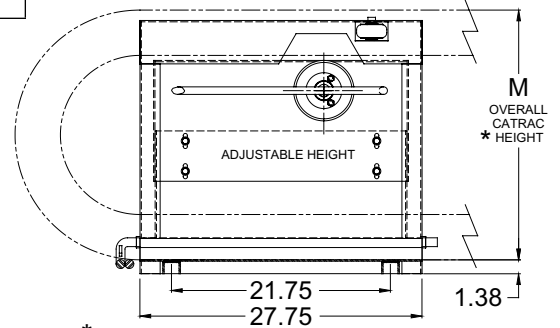

* NOTE: FOR CATRAC SYSTEMS WITH RETRACTABLE ROLLER SUPPORTS, OVERALL HEIGHT OF SYSTEM WILL BE INCREASED BY 1.38" UNLESS RETRACTABLE ROLLER SUPPORT BASE IS RECESSED.

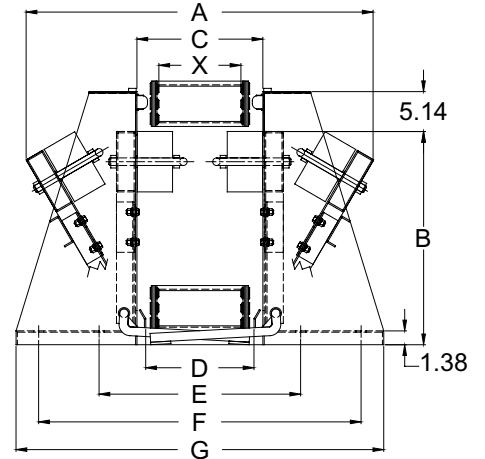

304, 456, 606, 808 Styles of CATRAC*						
Carrier Width	A Dim.	C Dim.	D Dim.	E Dim.	F Dim.	G Dim.
8.00	34.50	12.50	10.75	20.00	32.00	36.50
x	x + 26.50	x + 4.50	x + 2.75	x + 12.00	x + 24.00	x + 28.50
Nuts Out	Consult Factory					
*375 Style Consult Factory.						
Note: Approximate dimensions, not for construction unless certified. All dimensions in inches unless otherwise specified.						

T = TOTAL TRAVEL UL = MAXIMUM UNSUPPORTED LENGTH

TWO STATIONARY ROLLER SUPPORT $UL = \frac{T}{4}$

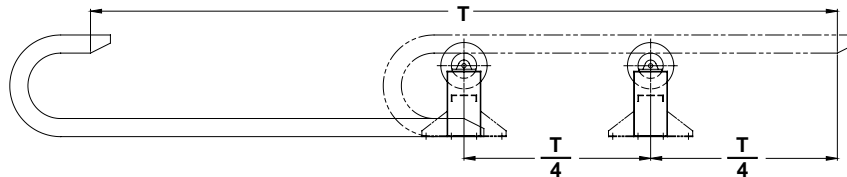

TWO STATIONARY ROLLER SUPPORT $UL = \frac{T}{6}$

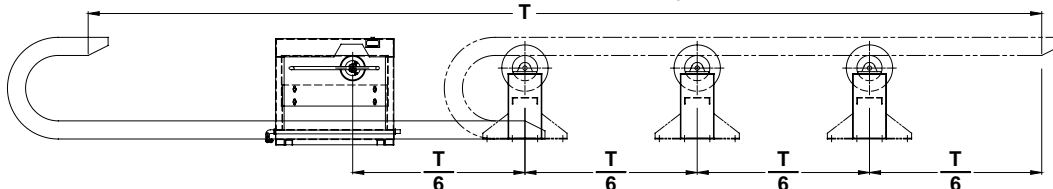



CATRAC® Carriage Support System

Carriage Support Systems

Carriage support systems are used when cable/hose loads and travel exceed the limits available with fixed roller supports and designed for applications requiring long travels, high speeds, quick accelerations and constant cycling. These systems are normally used in

conjunction with 304 and 456 CATRAC styles. Special Mill-Duty carriage support systems are available for extreme environments. Some of the varieties available are shown on this page. Call our application engineers for more information at 800.325.8074.

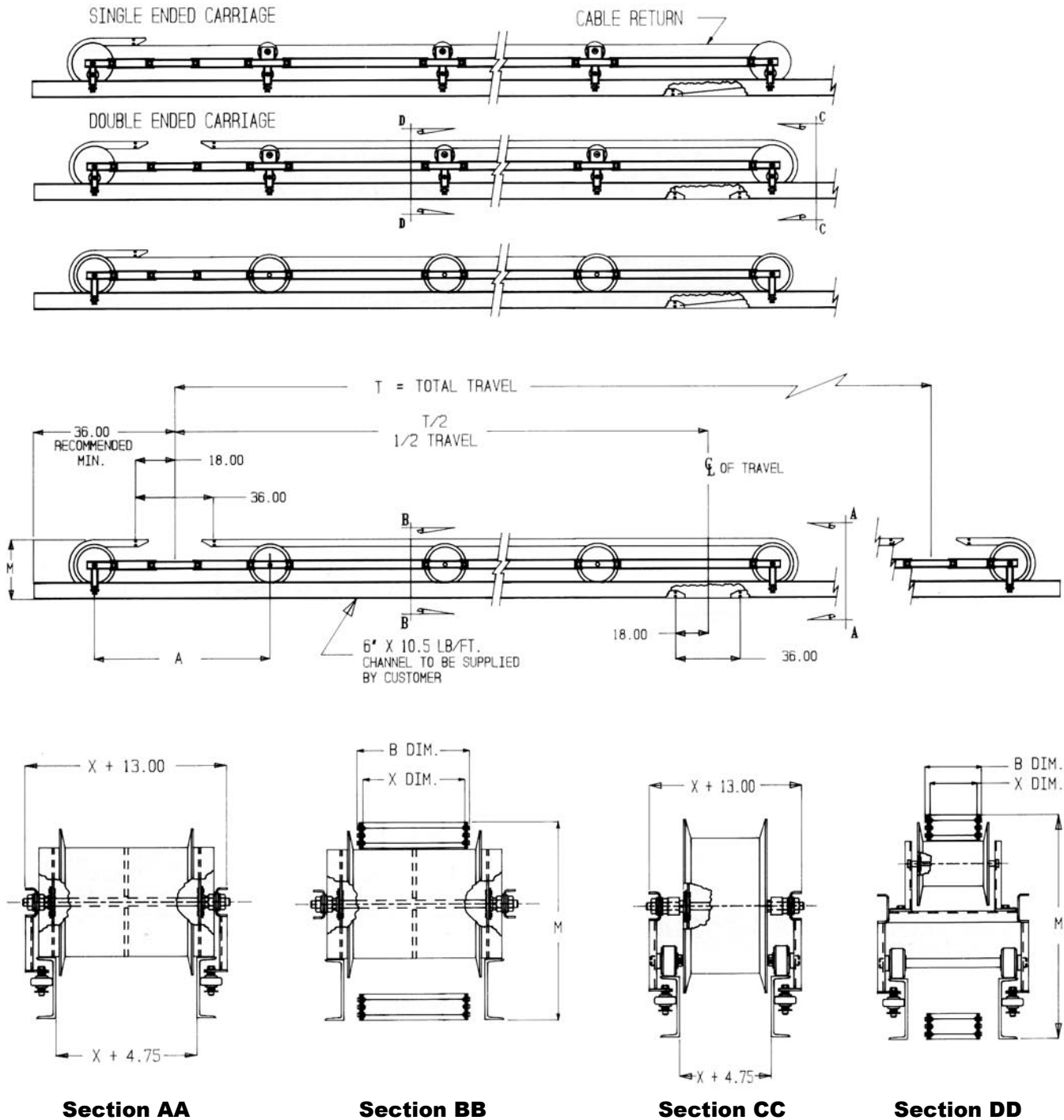



CATRAC® Applications

CATRAC® Applications

Primary Metals

Tundish Cars
Ladle Cars
Torch Cut Off Machines
Slab Markers
Mud Gun
Ladle Lance
Pickling Line
Strip Mills
Furnaces
“Dummy” Bar
Continuous Annealing Lines

Construction Machinery

Manlifts
Aerial Lifts
Utility Trucks
Underground Boring

Milling/Drilling Machinery

Drilling Machines
Offshore Drilling Platforms

Rolling Mill Machinery

Coil Processing Equipment
Slitting Line
Roll Grinders
Walking Beam

Machine Tool & Specialty Equipment

Lathes
Milling Machines
Routers
Shearing
Stamping
Loaders/Extractors
Flame Cutters
Automatic Vehicle Wash
Gantry Crane
Part Shuttles
Press Feeders
High-Pressure Water Washdown Equipment
Stackers/Reclaimers
X-Ray Gauges

Packaging/Material Handling

Palletizers
Wrappers
Shuttles
Rubber Tired Vehicles
Factory Automation
Automation Storage & Retrieval System

Other

Pulp/Paper Industry
Lumber Industry

Hot/Cold Strip Mills

Walking Beam
Reheat Surface
Coil Buggies
X-Ray Machines
Slitter Machines
Back Up Roll Sleds
Pay Off Reel
Coil Upender
Entry/Exit Cars

CATRAC Automotive Applications

Stamping Related

Coil Handling Equipment
Die Transfer Carts
Shuttles
In Die Transfer Equipment
Stacker & Destacker Equipment
Stamping Press Heads

Assembly Plants

Radiator Fluid Filling Lines
Brake Fluid Filling Lines
Body Transfer Lines
Welding Lines
Chassis Assembly Lines

Raw Material

Loading/Unloading Cranes
Stacker/Reclaimer Cranes

Steel Making

Ladle Lance
Ladle Transfer Cars
Tundish Cars
Starter Bar
Torch Cut-Off Machine
Run Out Table
Soaking Pit Transfer Car
Scarfig Machine



Steel Mill Applications

Mining - Iron Ore - Coal - Limestone

Ore Beneficiation

Preparation
Cleaning
Belt Trippers
Stackers
Reclaimers
Bedding Machines
Trenchers

Shipping - Rail - Water - Raw Material Storage

Stackers
Reclaimers
Belt Trippers
Car Dumpers

Integrated Steel Making Plants

Raw Material - Storage & Preparation

Stackers
Reclaimers
Belt Trippers
Car Dumpers
Trenchers

Sinter Plants

Belt Trippers
Bedding Machine
Trenching Machine
Reclaimer

Coke Oven Batteries

Coal Preparation - Coke Storage

Stackers
Reclaimers
Belt Trippers
Trenchers

Coke Battery Ovens - Coal Side

Lary Charge Cars
Smoke Blow Pipe Cleaners
Charge & Cover Machine
Pushing Machine - Levelers

Coke Battery Ovens - Coke Side

Door Machine
Smoke Suppressor
Quench Cars
Wharf Plows

Blast Furnaces

Taphole Drills
Mud Guns
Burden Distributor Car
Sensing Lances

Steel Making Open Hearth

Charging Machine
Ladle Transfer Cars
Hot Metal (Molten Iron)
Teeming Aisle (Molten Steel)
Slag Pot
Mold Preparation Vacuum & Dust Machine

Basic Oxygen Furnace (BOF)

Scrap Prep. Cutting Gantry
Water Cooled Doors
Removable Hood Section
Belt Tripper - Flux Handling
Refractory Gunning Machines
Lance Carriage
Horizontal
Preheat
Temperature Data
Ladle Transfer Cars
Hot Metal (Molten Iron)
Teeming Aisle (Molten Steel)
Slag Pot
Argon Lance

Electric Furnace

Ladle Transfer Cars
Furnace Tilt
Teeming Aisle (Molten Steel)
Cover Turn
Charge Machines
Argon Lance

Continuous Casting - Slab, Boom, Billet

Ladle Transfer Car
Tundish
Transfer Car
Heat Shield Car
Pouring Station
Shroud Positioner
Starting Bar
Transfer Car
Heat Shield Car
Pouring Station
Shroud Positioner
Starter Bar
Storage Rack
Cut Off Machine
Torch Machine
Cutoff Torch Traverse
Torch Edge Cutting Machine
Upcut Shear
Slab Sizing Mill - Roll Sleds
Stamping Marking Machine
Disappearing Stop
Piler - Pusher

Slab, Blooming, Billet Mills - Shapers

Soaking Pit Transfer Cars
Double Manipulator - Rolling Edge Guides
Roll Sleds
Scarving Machine
Supply
Adjustable Heads
Crop Shear
Marking - Stamping Machine

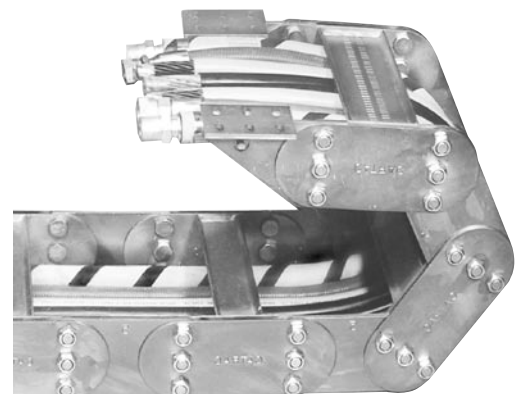



Steel Mill Applications

Hot Strip Mills

Primary Rolling

Roll Sleds, Backup and Work Roll
Vertical Scale Breaker
Horizontal Scale Breaker
Roughing Mills
Finishing Mills
Descale Systems
Morgoil Lubrications
Coilers
Mandrel Carriage
Stripper Cars
X-Ray Machines

Finishing - Processing

Transfer Cars
Oil Buggies
Combo Line
Skin Pass Line
Slitters & Shears
Coil Carrier Hook
Walking Beam Coil Transfer

Auxiliaries

Transfer Cars
Work Rolls
Backup Rolls
Bearing Extractor Car

Sheet Mills - Cold Rolling

Continuous Pickling Line

Entry Coil Cars - Buggies
Welders
Tension Wheels - Exit Coil Cars
Mandrel Carriages - Coilers
Belt Wrappers
Oilers
Pay Off Reels
Upender/Downender
Tandem Cold Rolling Mills
Coil Transfer Cars
Entry Horn Car
Quick Work Roll Change Car
Backup Roll Sled
Work Roll Turntable Sled
Belt Wrapper Transfer
Lift & Turn Coil Transfer

Temper Mill - Single Stand - Duo Mill

Coil Prep & Transfer
Entry Coil Car
Quick Work Roll Change Car
Exit Transfer Car
Back Uproll Sleds

Auxiliary Cold Mill Equipment

Dechocking Car - Roll Shop
Lathes & Grinders - Roll Shop
Slitter & Shear Process Lines
Entry & Exit Coil Cars
Recoil Mandrel Carriage
Payoff Reels
Belt Wrapper Transfer
Coil Band & Strapping
Upender/Downender

Continuous Anneal Lines

Exit & Entry Coil Cars
X-Ray Machines
Tension Reel Mandrel Carriages
Coating & Plating
Lines - Tin - Al - Chrome - Zinc
Galvanize
Vertical Spangle Unit
Horizontal Steam Supply
Zinc Hot Metal Pot
Welding Machine
Corrugating Lines
Upender/Downender

Plate Mills

Roll Change Sleds
Morgoil & Lube Systems
X-Ray Gauge
Descale Piping
Side Shear & Edge Gauge
End Gauge
Leveler

Structural Mills - Rail Mills

Rolling Mill Sleds
End Shear
Straightener

Bar and Rod Mills

Roll Sleds
End Shears
Straightener
Coiler Mandrel Carriage

Seamless and Butt Weld Pipe Mills

End Piercing Machine
Billet Charging Machine

Roll Shops

Grinders
Lathes
Chock Extractors
Roll Transfer Cars

Auxiliary Process Lines

Tension Leveling

Degreasing

Paint Coating

Shear

Shot Blast

Cut to Length

Slitting Line

Continuous Paint Line

Galvanize Line

Edge Trim Line

Grind & Polish

Anneal

Embossing

Side Trim

Chrome - TFS

Tin Line



Mill-Duty CATRAC®

CATRAC® MD for the Primary Metals Industry

This industry readily accepts only those products that are made exceptionally strong to the point of being "overbuilt". If the product doesn't look like it belongs in that environment, it doesn't.

Reliability is the Foremost Requirement

This industry knows no product that they can't destroy regularly, our mill-duty CATRACs are designed to be the most rugged assemblies available.

CATRAC is Stronger

All steel construction fabricated from 80,000 lb. tensile steel links, assembled with 9/16, 3/4 or 1" hardened shoulder bolts and locknuts, welded box beam carriers absorb side thrust loads, can be made to travel and span the longest distances in the industry.

Cable & Hose Replacement is Easy

The box beam carrier has free space that allows the bad cable or hose to be easily snaked out. The carrier bars can have spring loaded retaining rods, allowing the whole bundle of hoses to be removed and replaced at once.

CATRAC is Field Repairable

Because the CATRAC is all steel, it can be straightened or welded in position. It can be easily unbolted to replace carriers and links.

CATRAC Value

The competitively priced CATRAC offers more options for your dollar. Since 1967, CATRAC brand carriers have been solving customer problems. These years of experience have supplied us with an opportunity to provide solutions for numerous applications. This data allows us to incorporate new and better features into all CATRAC styles.

Available in Any and ALL Sizes

Made to any width or radius with more hose and cable carrying capacity in a box beam carrier, it can handle 8" I.D. hose or 12" O.D. cable. We also offer multiple widths and double deck carrier assemblies.

Retrofit into Present Track Systems

CATRAC is the only known track that can be easily and regularly made to retrofit into competitors original applications. We need only four dimensions to build CATRAC:

- Track Height - "M"
- Track Height - "B"
- Track Height - "TL"
- Hose & Cable Clearance - "HC"

We'll deliver a stronger system quicker, and at a minimum cost.

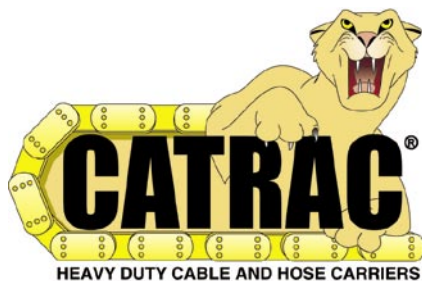
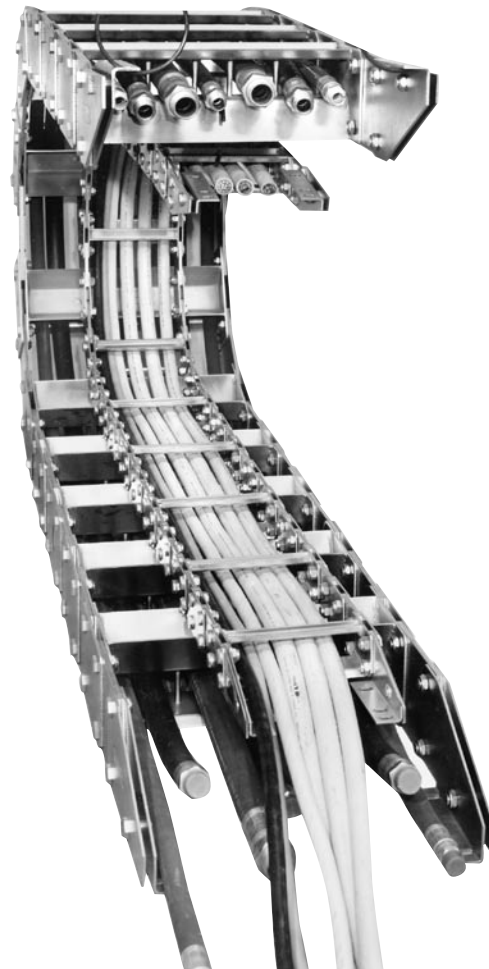

Chip Covers

Stainless steel chip covers protect hoses against damage from hot metal chips. The chip covers fit over the full length of the CATRAC® assembly, on either the top or bottom or both sides for maximum protection. The ends of the chip covers extend six inches beyond the ends of the CATRAC assembly for attachment. Chip covers should be fastened on either end to allow them to roll with the CATRAC. When ordering, specify either outside or inside covers or both.

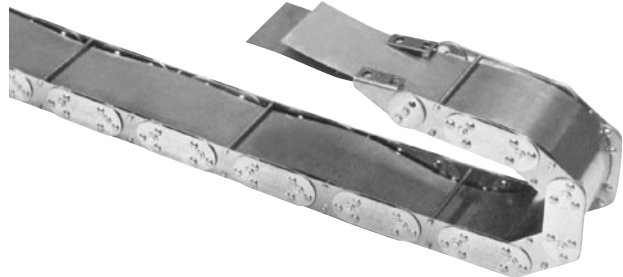

Heavy Duty Mounting Feet

Heavy Duty horizontal and vertical mounting feet are made from 3/16" or 1/4" plate steel and provide the ultimate in strength at the mounting point. Typical applications include mill duty equipment and high speed applications. Custom designs are also available upon request.

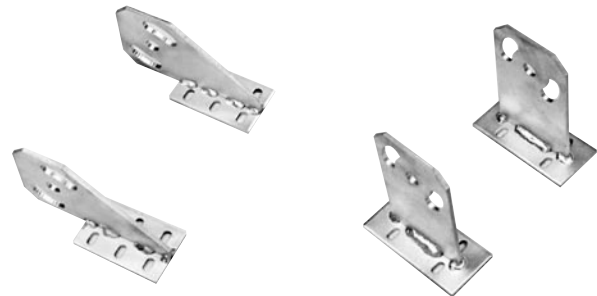

Glide Bars and Transfer Bar for Side Mounted Applications

We offer a wide range of options for side mounted applications including Nylatron glide bars, round pads and steel or stainless steel ball casters. We can side mount virtually any style of CATRAC. Dual radius CATRACS are also available for rotary applications.

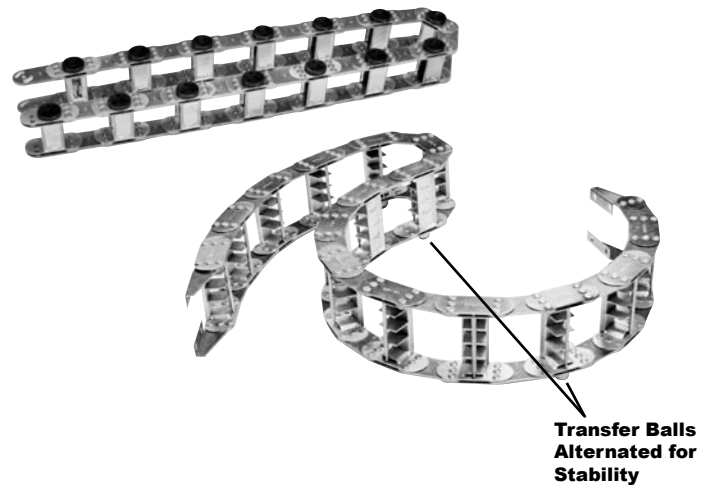

Multiple Carrier Widths

All styles of 3 Pin Center Pivot CATRAC are available in multiple widths. This type of construction provides additional strength in wide systems. When width is a problem double decking of compartments is also available.





SnapTrac[®] Nylon Carriers

Available in a Variety of Sizes

SnapTrac[®] was developed to offer a light weight, low cost carrier for protected and controlled movement of cables and hoses. This corrosion resistant, nonconductive carrier is made of a longwearing nylon composition. SnapTrac can be used with electric, air, gas or hydraulic hoses.

A variety of carriers are available offering solutions for every type of travel. Typical applications for this carrier include robotics, machine tools, and all types of industrial equipment. Our application engineers are at your disposal to study and solve problems related to complex applications.



Technical Characteristics

Light and secure even at high speeds, SnapTrac carriers will provide protection for the components inside the carrier. The carrier is durable against harsh corrosive environments as found in refineries and marine application, chemical fumes, refrigeration fluids, lubricating oils and solvent present in a temperature range from -13°F to 257°F.

Choosing a Carrier

The designer must consider the travel length of the carrier and the minimum bending radii of the hoses to be carried. The additional load per foot must also be considered.

Layout of Cable in Carrier

Observe the allowable minimum bending radii of the cables and hoses to be carried; it is advisable to add an additional 10%. Cables of small diameter may be grouped together and tied.

Options

- Enclosed Designs
- Vertical Separator
- Horizontal Separator
- Vertical/Horizontal Separators
- Drilled Frames





SnapTrac[®] Nylon Carriers

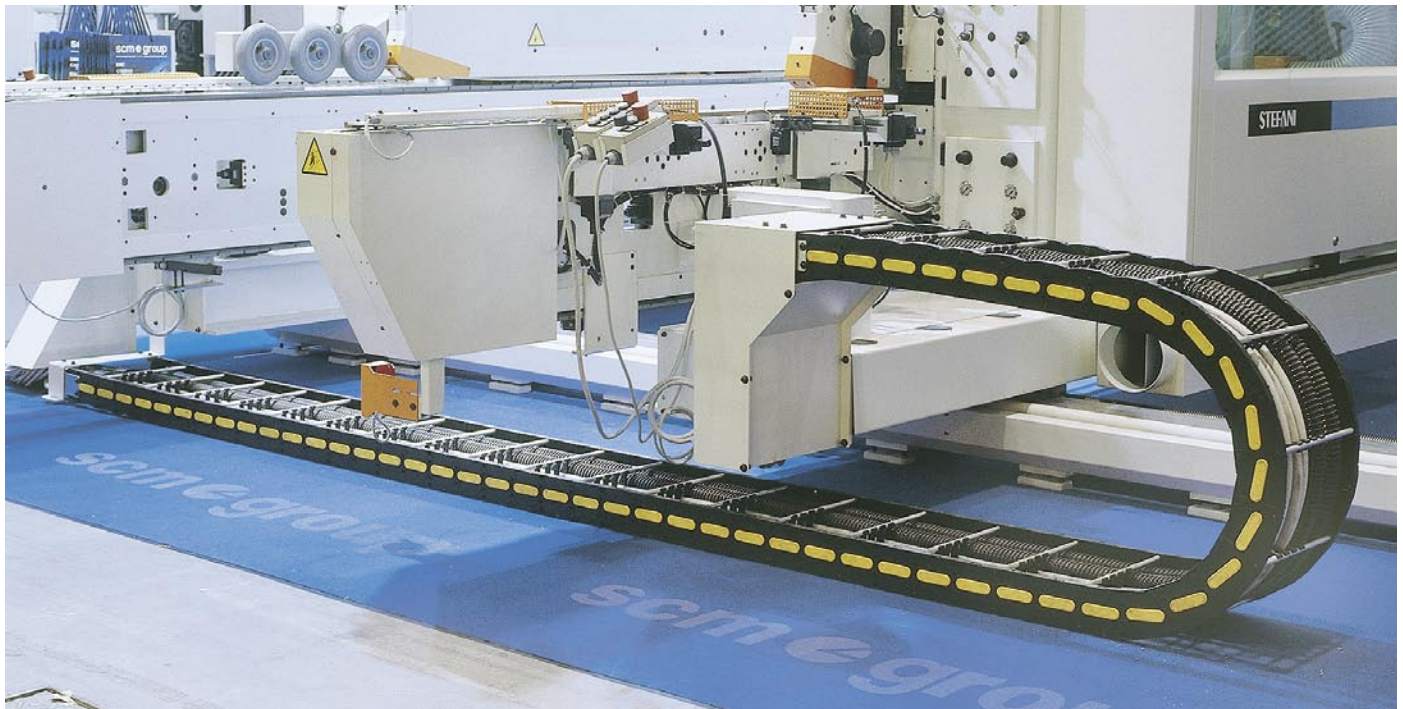

Light SnapTrac

Light series SnapTrac with small to medium sections for applications where high filling weight is not required.

Light SnapTrac					
Series	A External Width mm	B External Height mm	C Inner Width mm	D Inner Height mm	R Bending Radius mm
8061SR200	18-41	15	12-35	12	18-40
8061SR250	23	22	15	18	40
8061SR30090	29-49	23.5	18-38	18.5	33-100
8061SR325A	57-120	37	40-103	25.5	50-150
8061SR325	55-118	37	40-103	25.5	50-150

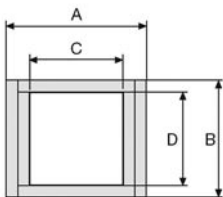

8061SR200

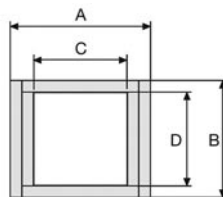

8061SR250

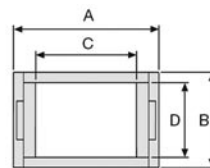

8061SR30090

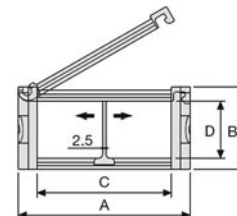

8061SR325A

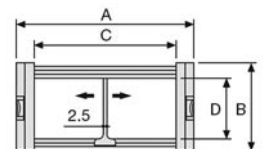

8061SR325



SnapTrac[®] Nylon Carriers

Medium SnapTrac

Small to medium size SnapTrac with yellow connecting pivot pins offer high capacity in high performance applications. Available with snap open cover or closed styles.

Medium SnapTrac					
Series	A External Width mm	B External Height mm	C Inner Width mm	D Inner Height mm	R Bending Radius mm
8061SR300A	27-87	23	15-75	18	40-120
8061SR300	30-52	23	14-36	18	40-120
8061SR305A	54-74	30	30-50	24	50-150
8061SR305	52-72	30	30-50	20	50-150
8061SR355A	74-124	43	45-95	31	75-200
8061SR355	74-124	45	45-95	30	75-200
8061SR400	62-82	35	40-60	25	50-150
8061SR435MI/ME	60-170	49	40-150	35	60-170
8061SR445MI/ME	72-384	64	50-362	45	75-300
8061SR660A	75-387	55	50-362	37	100-250
8061SR770A	80-392	78	45-357	60	150-300
8061SR475MI/ME	112-412	100.5	74-374	75.5	150-400

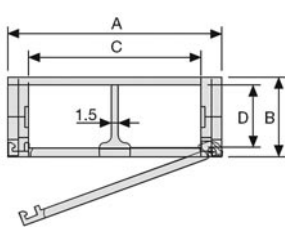
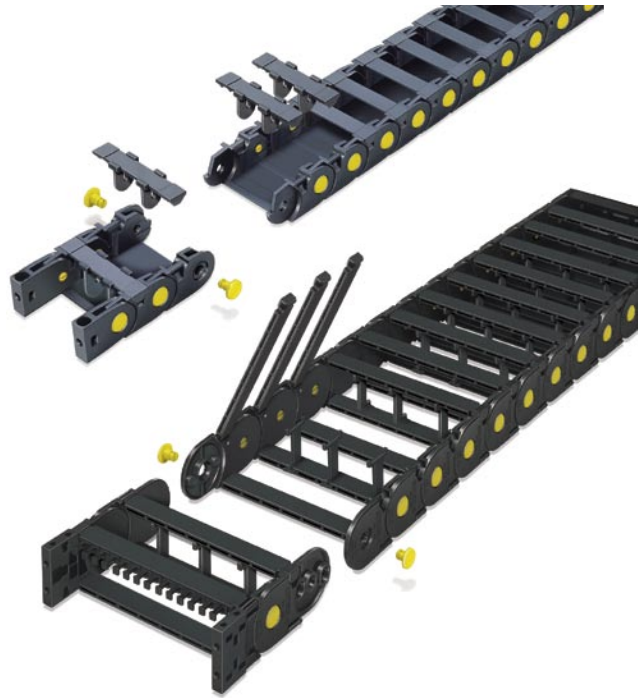

8061SR300A

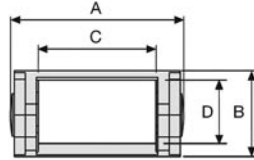

8061SR300

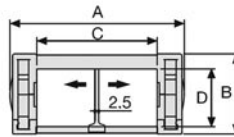

8061SR305A

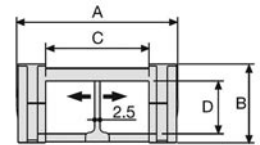

8061SR305

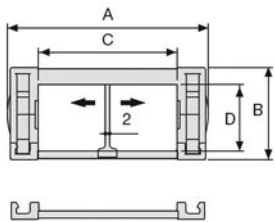

8061SR355A

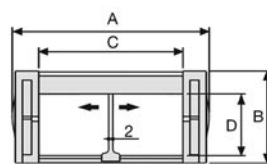

8061SR355

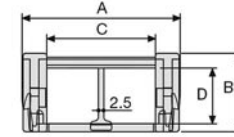

8061SR400

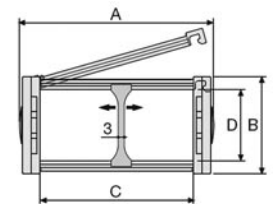

8061SR435MI/ME

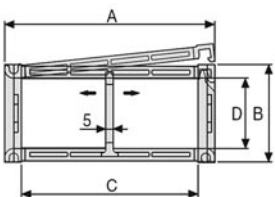

8061SR445MI/ME

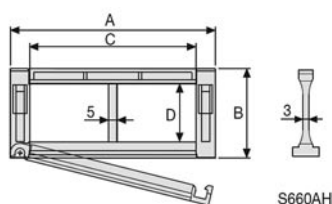

8061SR660A

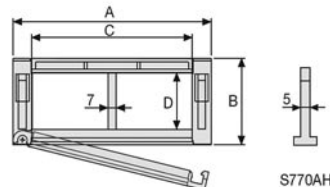

8061SR770A

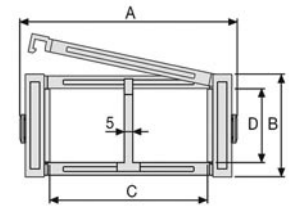

8061SR475MI/ME

Heavy SnapTrac

A strong design with triple connecting pivot pins. This design allows unsupported length up to 6.5 m and extends the service life of the SnapTrac and cables.

Heavy SnapTrac					
Series	A External Width mm	B External Height mm	C Inner Width mm	D Inner Height mm	R Bending Radius mm
8061SR308SI/SE	82-394	75	38-350	57	150-400
8061SR309SI/SE	120-420	100	64-364	75.5	200-500
8061SR310T	260-660	150	200-600	112	200-750

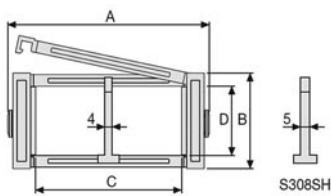

8061SR308SI/SE

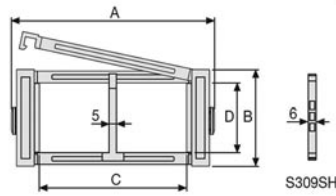

8061SR309SI/SE

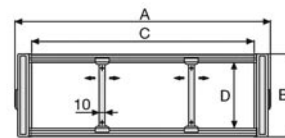

8061SR310T



Protection SnapTrac

A completely enclosed design prevents contact between cables, chips or dust. Each link has a quickly removable cover for easy installation of the cables and hoses.

Protection SnapTrac					
Series	A External Width mm	B External Height mm	C Inner Width mm	D Inner Height mm	R Bending Radius mm
8061SR435PI/PE	60-170	49	40-150	35	75-200
8061SR660	79-179	55	50-150	36	100-250
8061SR445PI/PE	72-384	64	50-362	45	100-300
8061SR770	120-285	78	85-250	51	150-300
8061SR309C	256-456	100	200-400	72	200-500
8061SR475PI/PE	112-412	100.5	74-374	75.5	180-400

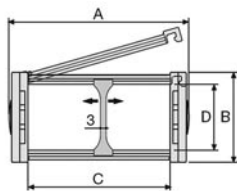

8061SR435PI/PE

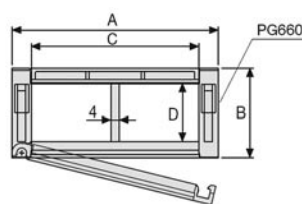

8061SR660

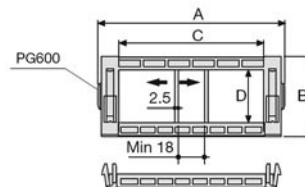

8061SR660

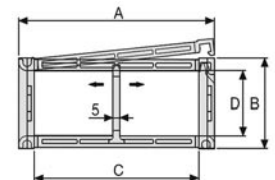

8061SR445PI/PE

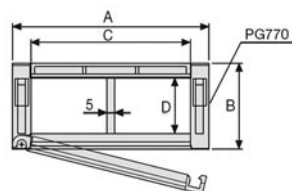

8061SR770

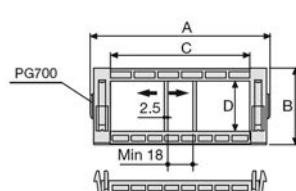

8061SR770

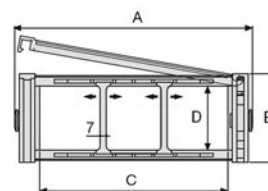

8061SR309C

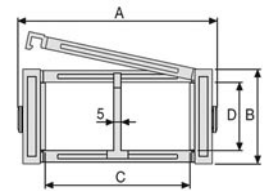

8061SR475PI/PE





SnapTrac[®] Nylon Carriers

Sliding SnapTrac

Sliding SnapTrac is made to be used where travel distance is long. The links are equipped with skids, allowing the trac to slide on itself. It is made of special polymers to reduce friction and wear.



Sliding SnapTrac					
Series	A External Width mm	B External Height mm	C Inner Width mm	D Inner Height mm	R Bending Radius mm
8061SR326SI/SE	106-418	59	61-373	37	107-300
8061SR328SI/SE	119-431	79	61-373	57	150-400
8061SR319B	164-464	107	100-400	70	200-500

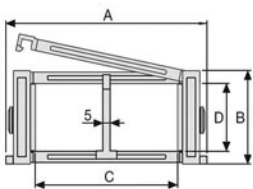

8061SR200

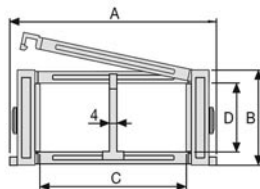

8061SR250

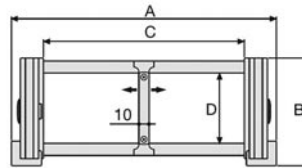

8061SR30090

Robot SnapTrac

SnapTrac offers an innovative solution for circular applications like welding and painting robots by allowing rotation of over 360°. Available in 9 different models, each link has an opening cross piece to allow easy installation of cables and hoses.

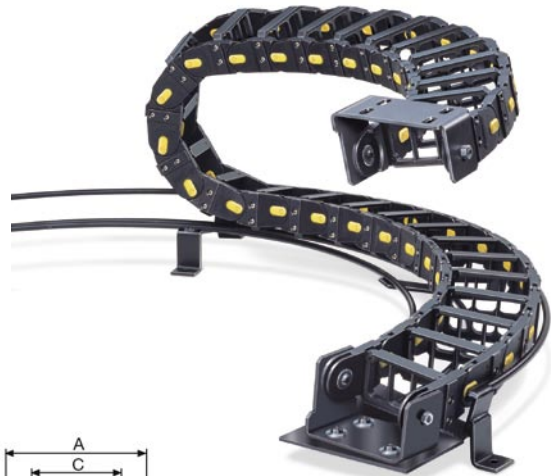

Robot SnapTrac					
Series	A External Width mm	B External Height mm	C Inner Width mm	D Inner Height mm	R Bending Radius mm
8061SR495	69	45	45	35	100
8061SR500	93	43	65	30	100-150
8061SR510TN	132	55	88	46	125
8061SR515TN	132	55	88	46	175
8061SR545	123	62	100	46	100
8061SR599	272	85	210	59	220

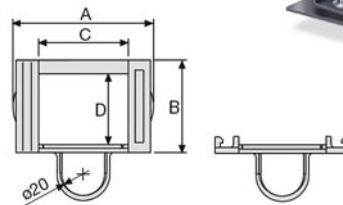

8061SR200

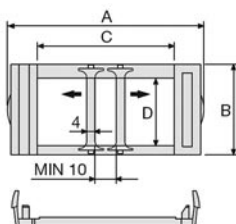

8061SR250

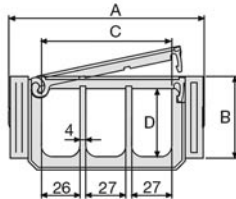

8061SR30090

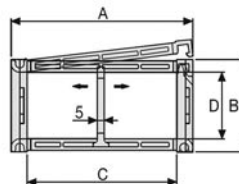



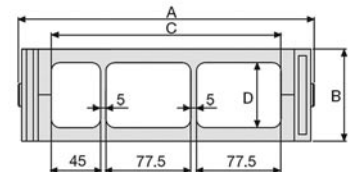

8061SR325A



8061SR200



AMETEK APT Products

	 <ul style="list-style-type: none"> LINEAR DISPLACEMENT TRANSDUCERS PLC INTERFACE PRODUCTS ROTARY POSITION PRODUCTS PROGRAMMABLE LIMIT SWITCHES EXTREME DUTY CABLE REEL PRODUCTS ROTARY LIMIT SWITCHES RESOLVERS MILL DUTY ENCLOSURES ULTRA HIGH SPEED PLS SAFETY PRODUCTS 	
		

Copyright 2005 by AMETEK AUTOMATION & PROCESS TECHNOLOGIES. All Rights Reserved. Made in the USA.



6380 Brockway Road, Peck, MI 48017
 Phone: 810.378.5511 Toll Free: 800.325.8074
 Fax: 810.378.5516 www.AMETEKAPT.com

8060.C3R
 11/05.Z88
 2M

