



Section 5 Dedicated Timers

Note: DIN Rail Mounting Product pages are not included in this catalog.
Go to: www.ssac.com/sg5.pdf
Click on the Product Name
(ie: CT-SDS) to open the catalog page.
[Adobe Acrobat Reader is required]

Single Function



Delay on Make (ON Delay)	
Relay Output	5.2
Solid State Output	5.16
DIN Rail Mounting	see Note above
Delay on Make, Normally Closed	
Solid State Output	5.34
Delay on Break (OFF Delay)	
Relay Output	5.42
Solid State Output	5.54
DIN Rail Mounting	see Note above
True Delay on Break (without auxiliary voltage)	
Relay Output	see Note above
Solid State Output	see Note above
Single Shot (Pulse Former)	
Relay Output	5.70
Solid State Output	5.84



Single Shot, Retriggerable (Watchdog, Zero Speed)	
Relay Output	5.96
DIN Rail Mounting	see Note Above
Trailing Edge Interval	
DIN Rail Mounting	see Note Above
Interval (Impulse ON)	
Relay Output	5.100
Solid State Output	5.108
DIN Rail Mounting	see Note above
Recycling & Percentage	
Relay Output	5.126
Solid State Output	5.138
Recycling Flashers	
DIN Rail Mounting	see Note above

5

Sequencer



SQ3 & 4 -- Solid State Output	5.154
-------------------------------------	-------

Dual Function



Delay on Make/Delay on Break	
TDMB -- Plug-In	5.156
DIN Rail Mounting	
CT-MXS.xx	see Note above
Delay on Make/Interval	
ESD5 -- Solid State	5.158

HVAC Timers



Solid State Output	
TAC1 -- Anti Short Cycle Random Start ..	5.160
T2D -- Anti Short Cycle, Random Start ...	5.162
TAC4 -- Bypass Timing	5.164
TA -- Anti Short Cycle (DOB)	5.166
TL -- Anti Short Cycle (DOB)	5.168
CT -- Fan Delay	5.170

Vending Timers



HRV -- Relay Output	5.172
THC/THS -- Solid State Output	5.94
KSPU -- Solid State Output	5.176
NHPU -- Solid State Output	5.178

Star Delta Motor Starting



DIN Rail Mounting	
CT-SDS	see Note above
CT-SDE	see Note above
CT-YDE	see Note above

Delay On Make/Delay On Break

TDMB Digi-Set

Time Delay Relay



5

- Switch Settable Time Delays From 0.1 s ... 10,230 s in 3 Ranges
- +/-2% Setting Accuracy
- +/-0.1% Repeat Accuracy
- SPDT or DPDT Output Relay
- 10 A Output Contacts

Approvals:

Description

The TDMB combines both delay on make and delay on break functions into one plug-in package. Selection of the time period is accomplished with dual switches, one for the ON delay and the other for the OFF delay. SPDT or DPDT output options provide isolated, 10 A switching capability.

Operation

Input voltage must be applied at all times. The output relay is de-energized. Upon closure of the initiate switch, the green LED glows and the delay on make time delay (T1) begins. At the end of T1, the output relay energizes and the red LED glows. When the initiate switch opens, the green LED turns OFF and the delay on break time delay (T2) begins. At the end of T2, the output relay de-energizes and the red LED turns OFF.

Reset: Removing input voltage resets time delay and output. Opening the initiate switch during the delay on make delay, resets T1. Closing the initiate switch during the delay on break delay, resets T2.

Function

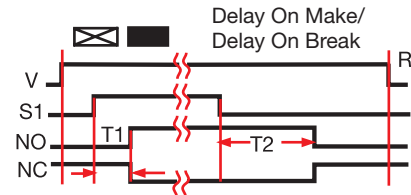

V = Voltage S1 = Switch Initiate R = Reset
 NO = Normally Open NC = Normally Closed
 T1 = Delay On Make Time T2 = Delay On Break Time
 — = Undefined time

Connection

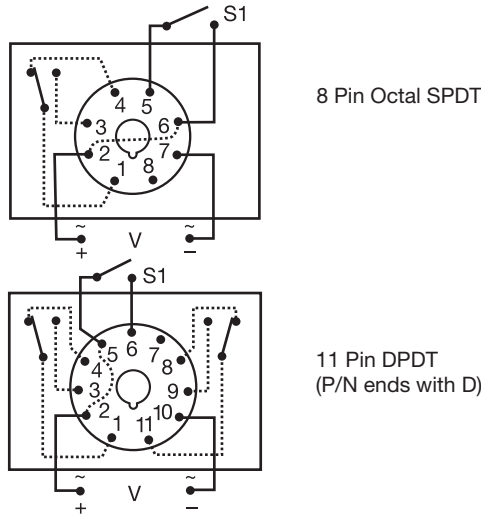

Relay contacts are isolated. Dashed lines are internal connections.

Accessories

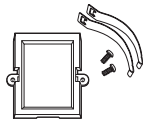

Panel mount kit
P/N: BZ1

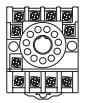

11 pin socket
P/N: NDS-11

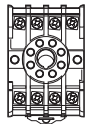

Octal
8 pin socket
P/N: NDS-8

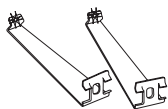

Hold down clips
P/Ns:
PSC8 (NDS-8)
PSC11 (NDS-11)

Ordering Table

TDMB	X	X	X	X
Series	Input	Delay On Make	Delay On Break	Type Plug/Output Form
	A - 24... 240 V AC/DC	1 - 0.1...102.3 s in 0.1 s increments	1 - 0.1...102.3 s in 0.1 s increments	D - 11 Pin Plug DPDT
	D - 12... 48 V DC	2 - 1...1023 s in 1 s increments	2 - 1...1023 s in 1 s increments	-Blank - Octal Plug
	1 - 12 V DC	3 - 10...10230 s in 10 s increments	3 - 10...10230 s in 10 s increments	(8 Pin) SPDT
	2 - 24 V AC			
	3 - 24 V DC			
	4 - 120 V AC			
	5 - 110 V DC			
	6 - 230 V AC			

NOTE: Options A & D qualify for Quickship delivery; grayed options require standard lead time.

Example P/N: TDMBA12 = 24-240 V, 0.1 to 102.3 s DOM; 1 to 1023 s DOB, 8 pin connection base
 TDMBD21D = 12-48V DC, 1 to 1023 s DOM; 0.1 to 102.3 s DOB, 11 pin connection base

Delay On Make/Delay On Break

TDMB Digi-Set

Time Delay Relay

Dedicated
timers

Technical Data

Time Delay		
Type		Microcontroller Circuitry
Range**		0.1 ... 102.3 s in 0.1 s increments 1 ... 1023 s in 1 s increments 10 ... 10,230 s in 10 s increments
Repeat Accuracy		+/-0.1% or 20 ms, whichever is greater
Setting Accuracy		≤ +/-2% or 50 ms, whichever is greater
Reset Time		≤ 150 ms
Time Delay vs. Temperature & Voltage		≤ +/-2%
Control LED Indicator		Green; ON when the initiate switch is closed
Input		
Voltage		12 or 24 V DC; 24, 120, or 230 V AC; 24... 240 V AC/DC; 12... 48 V DC
Tolerance	12 V DC & 24 V DC/AC 110 ... 230 V AC/DC	-15% ... +20% -20% ... +10%
Line Frequency / DC Ripple		50 ... 60 Hz / ≤ 10%
Power Consumption		AC ≤ 2 VA; DC ≤ 2 W
Output		
Type		Electromechanical relay
Form		SPDT or DPDT
Rating		10 A resistive at 120/240 V AC & 30 V DC; 1/3 hp at 230 V AC
Life		Mechanical -- 1 x 10 ⁷ ; Electrical -- 1 x 10 ⁵
Max. Switching Voltage		250 V AC
Relay LED Indicator		Red; ON when output relay energizes
Protection		
Insulation Resistance		≥ 100 M
Polarity		DC units are reverse polarity protected
Isolation Voltage		≥ 1500 V RMS input to output
Mechanical		
Mounting		Plug-in socket
Package		3.2 x 2.4 x 1.8 in. (81.3 x 60.7 x 45.2 mm)
Termination		Octal plug (8 Pin), magal plug (11 Pin)
Environmental		
Operating Temperature		-20°C ... +60°C
Storage Temperature		-30°C ... +85°C
Weight		≅ 6 oz (170 g)

5

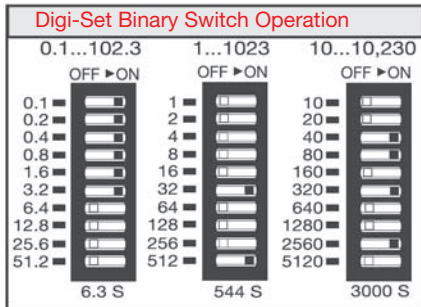

Add value of switches in ON position for total time delay.

Mechanical View

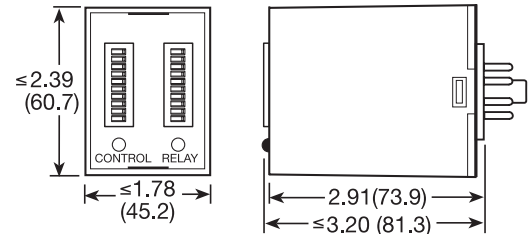

Inches (Millimeters)

Delayed Interval ESD5 Series Timing Module

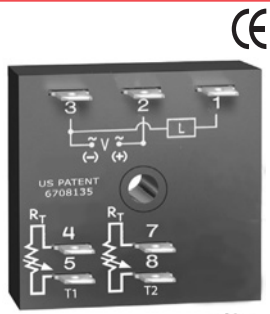

5

- Delay on Make with Interval Output
- 0.1 s ... 1000 m in 6 Ranges
- +/-0.1% Repeat Accuracy
- +/-5% Factory Calibration
- Factory Fixed; Onboard or External Adjust Time Delay
- Totally Solid State & Encapsulated
- 24, 120 or 230 V AC
- 1 A Solid State Output

Approvals:

Accessories

- External adjust potentiometer
P/Ns:
P1004-95 (fig A)
P1004-95-X (fig B)
- Mounting bracket
P/N: **P1023-6**
- Female quick connect P/N:
P1015-64 (AWG 14/16)
- Versa-knob
P/N: **P0700-7**
- Quick connect to screw adaptor
P/N: **P1015-18**
- DIN rail adaptor
P/N: **P1023-20**

See accessory pages for specifications.

Description

The ESD5 Series is an accurate solid state delayed interval timer. It offers a 1A steady/10A inrush output and is available with an adjustable or fixed time delays of 0.1 seconds to 1000 minutes in six ranges. Input voltages of 24, 120, or 230 V AC are available. Encapsulation offers protection against shock and vibration. Adjustment options are externally adjustable or factory fixed. The repeat accuracy, under stable conditions, is 0.1%. The factory calibration of the time delay is +/- 5%.

Operation

Upon application of input voltage, the T1 delay on make time delay begins and the output remains de-energized. At the end of this delay, the output energizes and the T2 interval delay begins. At the end of the interval delay period, the output de-energizes.

Reset: Removing input voltage resets the output and the time delays, and returns the sequence to the first delay.

Connection

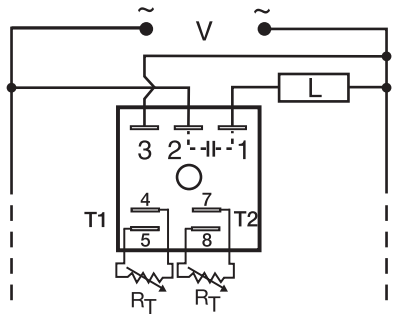

Note: Terminals 4, 5 and/or 7, 8 are included when external adjustment is ordered. A knob is included when onboard adjust is ordered.
R_e is the external adjustment component.
Dashed lines are internal connections.

Function

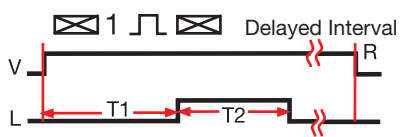

V = Voltage L = Load
T1 = OFF Time (Delay on Make)
T2 = ON Time (Interval) R = Reset
— = Undefined time

Ordering Table

ESD5 Series	X Input	X Adjustment	X T1 Delay On Make *	X T2 Interval *
	-2 - 24 V AC	-1 - Both Times Fixed	-0 - 0.1 ... 10 s	-0 - 0.1 ... 10 s
	-4 - 120 V AC	-2 - Both Times External Adj.	-1 - 1 ... 100 s	-1 - 1 ... 100 s
	-6 - 230 V AC	-3 - T2 External Adj., T1 Fixed	-2 - 10 ... 1000 s	-2 - 10 ... 1000 s
		-4 - T1 External Adj., T2 Fixed	-3 - 0.1 ... 10 m	-3 - 0.1 ... 10 m
		-5 - Both Times Onboard Adj.	-4 - 1 ... 100 m	-4 - 1 ... 100 m
		-6 - T2 Onboard Adj., T1 Fixed	-5 - 10 ... 1000 m	-5 - 10 ... 1000 m
		-7 - T2 Onboard Adj., T1 External Adj.		
		-8 - T1 Onboard Adj., T2 Fixed		
		-9 - T1 Onboard Adj., T2 External Adj.		

*If Fixed Delay is selected, insert delay [0.1...1000] followed by (S) sec. or (M) min.

Example P/N: **ESD54200** Fixed – **ESD54430.1S**

Delayed Interval ESD5 Series Timing Module

Dedicated
timers

Technical Data

Time Delay	
Range	100 ms ... 1000 m in 6 adjustable ranges or fixed
Repeat Accuracy	+/-0.1% or 20 ms, whichever is greater
Tolerance (Factory Calibration)	≤ +/-5%
Reset Time	≤ 150 ms
Time Delay vs. Temperature & Voltage	≤ +/-2%
Input	
Voltage	24, 120, or 230 V AC
Tolerance	+/-20%
Line Frequency	50 ... 60 Hz
Power Consumption	≤ 2 VA
Output	
Type	Solid state
Rating	1 A steady state, 10 A inrush at 60°C
OFF State Leakage Current	≅ 5 mA at 230 V AC
Voltage Drop	≅ 2.5 V at 1 A
Protection	
Circuitry	Encapsulated
Dielectric Breakdown	≥ 2000 V RMS terminals to mounting surface
Insulation Resistance	≥ 100 MΩ
Mechanical	
Mounting	Surface mount with one #10 (M5 x 0.8) screw
Package	2 x 2 x 1.21 in. (50.8 x 50.8 x 30.7 mm)
Termination	0.25 in. (6.35 mm) male quick connect terminals
Environmental	
Operating Temperature	-40°C ... +75°C
Storage Temperature	-40°C ... +85°C
Humidity	95% relative, non-condensing
Weight	≅ 2.4 oz (68g)

5

External Resistance vs Time Delay

In Secs. or Mins.

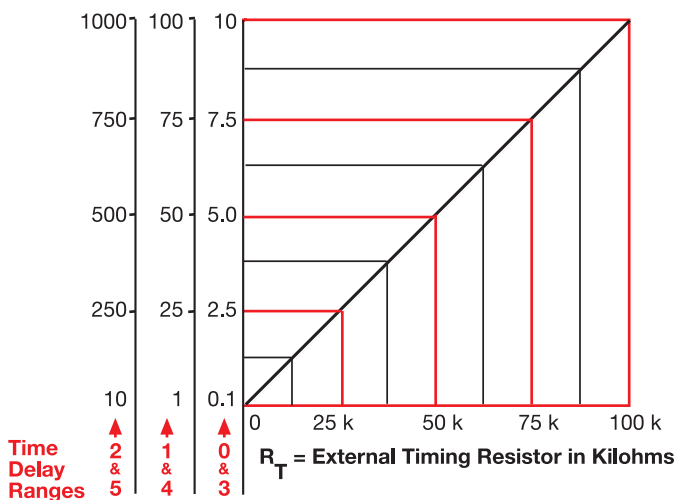

This chart applies to externally adjustable part numbers.
 The time delay is adjustable over the time delay range selected by varying the resistance across the R_T terminals; as the resistance increases the time delay increases.
 When selecting an external R_T , add the tolerances of the timer and the R_T for the full time range adjustment.
Examples: 1 to 50 S adjustable time delay, select time delay range 1 and a 50 K ohm R_T . For 1 to 100 S use a 100 K ohm R_T .

Mechanical View

Fixed & External Adjust

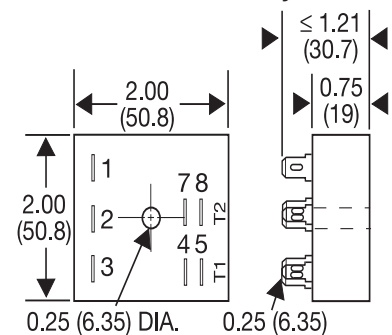

Onboard Adjust

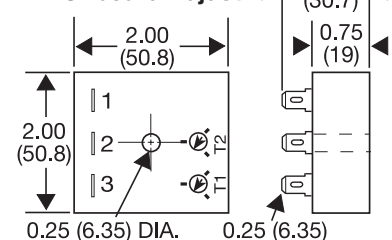

Inches (Millimeters)



Sales Information:

ABB Inc.
1206 Hatton Road
Wichita Falls, TX 76302
Telephone 888-385-1221; 940-397-7000
Fax 940-397-7085
<http://www.abb-control.com>

Technical Help and Product Support

ABB Inc.
Telephone 315-638-1300
Technical Help 800-377-SSAC (7722)
Fax 315-638-0333
<http://www.ssac.com>

Sales Information (Canada)

ABB Inc.
2105 32nd Avenue
Lachine, Quebec H8T 3J1
Canada

Telephone
Atlantic & Quebec Region: 800-567-0203
Ontario Region: 866-460-3300
Mid-West & Pacific Region: 866-222-8368