

3 Pole 30A – 800A

Disconnect
switches
Fusible
Enclosed



FJ30X-3P02A

3 Pole¹ , 600V, 30A – 800A

NEMA Enclosure type

UL general purpose amp rating	Fuse type	1		3R		4		4X Stainless		
		Catalog number	List price	Catalog number	List price	Catalog number	List price	Catalog number	List price	
	30	J	FJ301-3PB6B	\$ 560	FJ303-3PB6B	\$ 600	FJ304-3PB6B	\$ 1100	FJ30X-3PB6B	\$ 1400
	30	CC	FC301-3PB6B		FC303-3PB6B		FC304-3PB6B		FC30X-3PB6B	
	60	J ²	FJ601-3PB6B	660	FJ603-3PB6B	860	FJ604-3PB8B	1300	FJ60X-3PB8B	1800
	100	J ²	FJ1001-3PB8B	960	FJ1003-3PB8B	1140	FJ1004-3PB8B	2800	FJ100X-3PB8B	3800
	200	J ²	FJ2001-3PB4B	2200	FJ2003-3PB4B	2400	FJ2004-3PB4B	3900	FJ200X-3PB4B	5000
	400	J ²	FJ4001-3PB4B	3800	FJ4003-3PB4B	4200	FJ4004-3PB4B	7700	FJ400X-3PB4B	10,800
600	J ²	FJ6001-3PB4B	5300	FJ6003-3PB4B	6800	FJ6004-3PB4B	11,000	FJ600X-3PB4B	16,000	
800	L	FL8001-3PB4B	9500	FL8003-3PB4B	11,200	FL8004-3PB4B	16,000	FL800X-3PB4B	21,000	

3 Pole¹ , 600V, 30A – 800A

NEMA Enclosure type

UL general purpose amp rating	Fuse type	4X Plastic		12		
		Catalog number	List price	Catalog number	List price	
	30	J	FJ30P-3PB6B	\$ 1040	FJ302-3PB6B	\$ 600
	30	CC	FC30P-3PB6B		FC302-3PB6B	
	60	J ²	FJ60P-3PB8B	1300	FJ602-3PB6B	860
	100	J ²	FJ100P-3PB8B	2800	FJ1002-3PB8B	1140
	200	J ²	FJ200P-3PB4B	4400	FJ2002-3PB4B	2400
	400	J ²	FJ400P-3PB4B	8400	FJ4002-3PB4B	4200
600	J ²	FJ600P-3PB4B	13,600	FJ6002-3PB4B	6200	
800	L	FL800P-3PB4B	17,400	FL8002-3PB4B	9800	

NOTE: All enclosed switches are provided with a black handle; however, most handles can be substituted with a red / yellow handle if desired. Please substitute the handle suffix code (2nd and 3rd from last characters) with the red/yellow handle catalog number suffix from page 17.126. There is no additional price adder for changing to a red/yellow handle of equal ratings and style.

EXAMPLE: A red/yellow pistol handle for an FJ301-3PB6B can be substituted for the black pistol handle by using the "Y6" suffix instead of the "B6" suffix, new catalog number: FJ301-3PY6B.

¹ Fusible switches are UL listed to the UL98 standard.
² 600V T type fuse clips may be substituted at no charge. Please change the second character of the catalog number from "J" to "T."

Disconnect
switches
Fusible
Enclosed

Switch and handle ratings 30A – 800A

Switch ratings

UL general purpose amp rating	Maximum horsepower rating								Wire size for terminal lugs	For wire type	Approval ①
	Single phase			Three phase							
	120V	200V	240V	200V	208V	240V	480V	600V			
30	2	3	5	5	7.5	7.5	15	20	#18 – 8	Cu	CSA, UL
60	3	7.5	10	15	15	15	30	50	#14 – 4	Cu	CSA, UL
100	5	10	15	25	25	30	60	75	#14 – 2/0	Cu/Al	CSA, UL
200	—	—	—	50	50	60	125	150	#6 – 300 kcmil	Cu/Al	CSA, UL
400	—	—	—	100	125	125	250	350	#2 – 600 kcmil	Cu/Al	CSA, UL
600	—	—	—	150	150	200	400	500	(2) #2 – 600 kcmil	Cu/Al	CSA, UL
800	—	—	—	200	200	250	500	600	(2) #2 – 600 kcmil	Cu/Al	CSA, UL

Handle ratings

Amperage range	Style type	NEMA	Color	Marking	Defeatable	Padlockable	Catalog number suffix	Catalog number
30	Selector	1,3R,12	Black	O/I & OFF/ON	Yes	Yes	BJ	OHB2AJ
	Selector	1,3R,12	Red/Yel				YJ	OHY2AJ
	Pistol	1,3R,12	Black				B6	OHB65J5
	Pistol	1,3R,12	Red/Yel				Y6	OHY65J5
	Pistol	1,3R,4,4X,12	Black				B6	OHB65L5
Pistol	1,3R,4,4X,12	Red/Yel	Y6	OHY65L5				
60 – 100	Pistol	1,3R,12	Black	O/I & OFF/ON	Yes	Yes	B6	OHB65J6
		1,3R,12	Red/Yel				Y6	OHY65J6
		1,3R,12	Black				B8	OHB80J6
		1,3R,12	Red/Yel				Y8	OHB80J6
		1,3R,4,4X,12	Black				B8	OHB80L6
1,3R,4,4X,12	Red/Yel	Y8	OHY80L6					
200 – 800	Pistol	1,3R,12	Black	O/I & OFF/ON	Yes	Yes	B4	OHB145J12
		1,3R,12	Red/Yel		Yes		Y4	OHY145J12
		1,3R,12	Black		Yes		B7	OHB175J12
		1,3R,12	Red/Yel		Yes		Y7	OHY175J12
		1,3R 4,4X,12	Black		Yes		B4	OHB145L12
		1,3R,4,4X,12	Red/Yel		Yes		Y4	OHY145L12
		1,3R 4,4X,12	Black		Yes		B7	OHB175L12
		1,3R,4,4X,12	Red/Yel		Yes		Y7	OHY175L12
		1,3R,4,4X,12	Metal		No		8	YASDA-8
30	Pistol	1,3R,12	Black	I/O/II	Yes	Yes	B6	OHB65J6E011
		1,3R,4,4X,12					OHB65L6E011	
60 – 100	Pistol	1,3R,12	Black	I/O/II	Yes	Yes	B8	OHB80J6E011
		1,3R,4,4X,12					OHB80L6E011	
200 – 800	Pistol	1,3R,12	Black	I/O/II	Yes	Yes	B4	OHB145J12E011
	Pistol	1,3R,4,4X,12	Black		Yes		B4	OHB145L12E011
	Pistol	1,3R,12	Black		Yes		B7	OHB175J12E011
	Pistol	1,3R,4,4X,12	Black		Yes		B7	OHB175L12E011
	Metallic	1,3R,4,4X,12	Metal		No		21	YASDA-21
	Metallic	1,3R,4,4X,12	Metal		No		6	YASDA-6

① Fusible switches are UL listed to the UL98 standard.

2 & 4 Pole 30 – 800A

Disconnect
switches
Fusible
Enclosed

2 Pole, 600V, 30A – 800A

		NEMA Enclosure type								
		1		3R		4		4X Stainless		
UL general purpose amp rating	Fuse type	Catalog number	List price	Catalog number	List price	Catalog number	List price	Catalog number	List price	
	30	J	—	—	—	—	—	—	—	
	30	CC	—	—	—	—	—	—	—	
	60	J	—	—	—	—	—	—	—	
	100	J	FJ1001-2PB8B	\$ 864	FJ1003-2PB8B	\$ 1026	FJ1004-2PB8B	\$ 2735	FJ100X-2PB8B	\$ 3420
	200	J	FJ2001-2PB4B	1980	FJ2003-2PB4B	2160	FJ2004-2PB4B	3600	FJ200X-2PB4B	4500
	400	J	FJ4001-2PB4B	3420	FJ4003-2PB4B	3780	FJ4004-2PB4B	7775	FJ400X-2PB4B	9720
	600	J	FJ6001-2PB4B	4770	FJ6003-2PB4B	6120	FJ6004-2PB4B	11,520	FJ600X-2PB4B	14,400
	800	L	FL8001-2PB4B	8550	FL8003-2PB4B	10,080	FL8004-2PB4B	15,120	FL800X-2PB4B	18,900

		NEMA Enclosure type				
		4X Plastic		12		
UL general purpose amp rating	Fuse type	Catalog number	List price	Catalog number	List price	
	30	J	—	—	—	
	30	CC	—	—	—	
	60	J	—	—	—	
	100	J	FJ100P-2PB8B	\$ 2520	FJ1002-2PB8B	\$ 1026
	200	J	FJ200P-2PB4B	3960	FJ2002-2PB4B	2160
	400	J	FJ400P-2PB4B	7560	FJ4002-2PB4B	3780
	600	J	FJ600P-2PB4B	12,240	FJ6002-2PB4B	5580
	800	L	FL800P-2PB4B	15,660	FL8002-2PB4B	8820

4 Pole, 600V, 30A – 800A

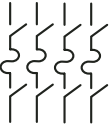
		NEMA Enclosure type								
		1		3R		4		4X Stainless		
UL general purpose amp rating	Fuse type	Catalog number	List price	Catalog number	List price	Catalog number	List price	Catalog number	List price	
	30	J	FJ301-4PB6B	\$ 700	FJ303-4PB6B	\$ 750	FJ304-4PB6B	\$ 1375	FJ30X-4PB6B	\$ 1750
	30	CC	FC301-4PB6B	—	FC303-4PB6B	—	FC304-4PB6B	—	FC30X-4PB6B	—
	60	J	FJ601-4PB6B	825	FJ603-4PB6B	1075	FJ604-4PB8B	1800	FJ60X-4PB8B	2250
	100	J	FJ1001-4PB8B	1200	FJ1003-4PB8B	1425	FJ1004-4PB8B	3800	FJ100X-4PB8B	4750
	200	J	FJ2001-4PB4B	2750	FJ2003-4PB4B	3000	FJ2004-4PB4B	5000	FJ200X-4PB4B	6250
	400	J	FJ4001-4PB4B	4750	FJ4003-4PB4B	5250	FJ4004-4PB4B	10,800	FJ400X-4PB4B	13,500
	600	J	FJ6001-4PB4B	6625	FJ6003-4PB4B	8500	FJ6004-4PB4B	16,000	FJ600X-4PB4B	20,000
	800	L	FL8001-4PB4B	11,875	FL8003-4PB4B	14,000	FL8004-4PB4B	21,000	FL800X-4PB4B	26,250

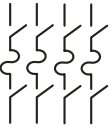
		NEMA Enclosure type				
		4X Plastic		12		
UL general purpose amp rating	Fuse type	Catalog number	List price	Catalog number	List price	
	30	J	FJ30P-4PB6B	—	FJ302-4PB6B	—
	30	CC	FC30P-4PB6B	\$ 1300	FC302-4PB6B	\$ 750
	60	J	FJ60P-4PB8B	1625	FJ602-4PB6B	1075
	100	J	FJ100P-4PB8B	3500	FJ1002-4PB8B	1425
	200	J	FJ200P-4PB4B	5500	FJ2002-4PB4B	3000
	400	J	FJ400P-4PB4B	10,500	FJ4002-4PB4B	5250
	600	J	FJ600P-4PB4B	17,000	FJ6002-4PB4B	7750
	800	L	FL800P-4PB4B	21,750	FL8002-4PB4B	12,250

**Disconnect
switches
Fusible
Enclosed**

6 Pole & Mechanically interlocked switches 30 – 800A

6 Pole, 600V, 30A – 800A

NEMA Enclosure type

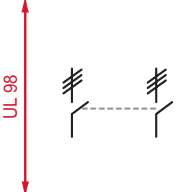
UL general purpose amp rating	Fuse type	1		3R		4		4X Stainless		
		Catalog number	List price	Catalog number	List price	Catalog number	List price	Catalog number	List price	
	30	J	FJ301-6PB6B	\$ 1300	FJ303-6PB6B	\$ 1400	FJ304-6PB6B	\$ 2150	FJ30X-6PB6B	\$ 3020
	30	CC	FC301-6PB6B		FC303-6PB6B		FC304-6PB6B		FC30X-6PB6B	
	60	J	FJ601-6PB4B	1450	FJ603-6PB4B	1600	FJ604-6PB4B	2450	FJ60X-6PB4B	3820
	100	J	FJ1001-6PB4B	2000	FJ1003-6PB4B	2200	FJ1004-6PB4B	3375	FJ100X-6PB4B	7820
	200	J	FJ2001-6P8B	4450	FJ2003-6P8B	4850	FJ2004-6P8B	7600	FJ200X-6P8B	10,560
	400	J	FJ4001-6P8B	7350	FJ4003-6P8B	8050	FJ4004-6P8B	15,950	FJ400X-6P8B	22,160
	600	J	FJ6001-6P8B	10,050	FJ6003-6P8B	13,000	FJ6004-6P8B	23,450	FJ600X-6P8B	32,560
	800	L	FL8001-6P8B	17,600	FL8003-6P8B	20,600	FL8004-6P8B	30,650	FL800X-6P8B	42,560

NEMA Enclosure type

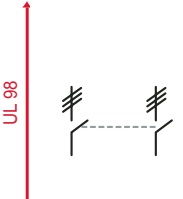
UL general purpose amp rating	Fuse type	4X Plastic		12		
		Catalog number	List price	Catalog number	List price	
	30	J	FJ30P-6PB6B	\$ 1575	FJ302-6PB6B	\$ 1480
	30	CC	FC30P-6PB6B		FC302-6PB6B	
	60	J	FJ60P-6PB4B	1820	FJ602-6PB4B	1850
	100	J	FJ100P-6PB4B	2475	FJ1002-6PB4B	2350
	200	J	FJ200P-6PB8B	8350	FJ2002-6PB8B	4850
	400	J	FJ400P-6PB8B	15,600	FJ4002-6PB8B	8050
	600	J	FJ600P-6P8B	25,000	FJ6002-6P8B	11,600
	800	L	FL800P-6P8B	31,800	FL8002-6P8B	18,150

Mechanically interlocked, 600V, 30A — 800A

NEMA Enclosure type

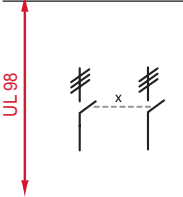
UL general purpose amp rating	Fuse type	1		3R		4		4X Stainless		
		Catalog number	List price	Catalog number	List price	Catalog number	List price	Catalog number	List price	
	30	J	FJ301-3MB6B	\$ 1420	FJ303-3MB6B	\$ 1560	FJ304-3MB6B	\$ 2400	FJ30X-3MB6B	\$ 3500
	30	CC	FC301-3MB6B		FC303-3MB6B		FC304-3MB6B		FC30X-3MB6B	
	60	J	FJ601-3MB6B	1620	FJ603-3MB6B	1780	FJ604-3MB8B	2750	FJ60X-3MB8B	4050
	100	J	FJ1001-3MB8B	2220	FJ1003-3MB8B	2440	FJ1004-3MB8B	3750	FJ100X-3MB8B	5500
	200	J	FJ2001-3MB4B	4960	FJ2003-3MB4B	5360	FJ2004-3MB4B	8450	FJ200X-3MB4B	10,560
	400	J	FJ4001-3MB4B	8160	FJ4003-3MB4B	8960	FJ4004-3MB4B	17,730	FJ400X-3MB4B	22,160
	600	J	FJ6001-3MB4B	11,160	FJ6003-3MB4B	14,460	FJ6004-3MB4B	26,050	FJ600X-3MB4B	32,560
	800	L	FL8001-3MB4B	19,560	FL8003-3MB4B	22,960	FL8004-3MB4B	34,050	FL800X-3MB4B	42,560

NEMA Enclosure type

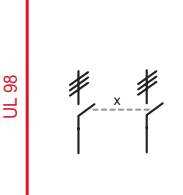
UL general purpose amp rating	Fuse type	4X Plastic		12		
		Catalog number	List price	Catalog number	List price	
	30	J	FJ30P-3MB6B	\$ 1750	FJ302-3MB6B	\$ 1650
	30	CC	FC30P-3MB6B		FC302-3MB6B	
	60	J	FJ60P-3MB8B	2020	FJ602-3MB6B	2020
	100	J	FJ100P-3MB8B	2750	FJ1002-3MB8B	2580
	200	J	FJ200P-3MB4B	9300	FJ2002-3MB4B	5360
	400	J	FJ400P-3MB4B	17,360	FJ4002-3MB4B	8960
	600	J	FJ600P-3MB4B	27,760	FJ6002-3MB4B	12,960
	800	L	FL800P-3MB4B	35,360	FL8002-3MB4B	20,160

Transfer and bypass switches 30 – 800A

Disconnect
switches
Fusible
Enclosed

3 Pole Transfer switch, 600V, 30A – 800A

NEMA Enclosure type

UL general purpose amp rating	Fuse type	1		3R		4		4X Stainless	
		Catalog number	List price	Catalog number	List price	Catalog number	List price	Catalog number	List price
	30	FJ301-3TB6B	\$ 1420	FJ303-3TB6B	\$ 1560	FJ304-3TB6B	\$ 2400	FJ30X-3TB6B	\$ 3500
	30	FC301-3TB6B		FC303-3TB6B		FC304-3TB6B		FC30X-3TB6B	
	60	FJ601-3TB8B	1620	FJ603-3TB8B	1780	FJ604-3TB8B	2750	FJ60X-3TB8B	4050
	100	FJ1001-3TB8B	2220	FJ1003-3TB8B	2440	FJ1004-3TB8B	3750	FJ100X-3TB8B	5500
	200	FJ2001-3TB4B	4960	FJ2003-3TB4B	5360	FJ2004-3TB4B	8450	FJ200X-3TB4B	10,560
	400	FJ4001-3TB4B	8160	FJ4003-3TB4B	8960	FJ4004-3TB4B	17,730	FJ400X-3TB4B	22,160
	600	FJ6001-3TB4B	11,160	FJ6003-3TB4B	14,460	FJ6004-3TB4B	26,050	FJ600X-3TB4B	32,560
	800	FL8001-3TB4B	19,560	FL8003-3TB4B	22,960	FL8004-3TB4B	34,050	FL800X-3TB4B	42,560

NEMA Enclosure type

UL general purpose amp rating	Fuse type	4X Plastic		12	
		Catalog number	List price	Catalog number	List price
	30	FJ30P-3TB6B	\$ 1750	FJ302-3TB6B	\$ 1650
	30	FC30P-3TB6B		FC302-3TB6B	
	60	FJ60P-3TB8B	2020	FJ602-3TB8B	2020
	100	FJ100P-3TB8B	2750	FJ1002-3TB8B	2580
	200	FJ200P-3TB4B	9300	FJ2002-3TB4B	5360
	400	FJ400P-3TB4B	17,360	FJ4002-3TB4B	8960
	600	FJ600P-3TB4B	27,760	FJ6002-3TB4B	12,960
	800	FL800P-3TB4B	35,360	FL8002-3TB4B	20,160

3 Pole Bypass switch, 600V, 30A – 800A

NEMA Enclosure type

UL general purpose amp rating	Fuse type	1		3R		4		4X Stainless		
		Catalog number	List price	Catalog number	List price	Catalog number	List price	Catalog number	List price	
	30	FJ301-3BB8B	\$ 1850	FJ303-3BB8B	\$ 2050	FJ304-3BB8B	\$ 3150	FJ30X-3BB8B	\$ 4550	
	30	FC301-3BB8B		FC303-3BB8B		FC304-3BB8B		FC30X-3BB8B		
	60	J	—	—	—	—	—	—	—	
	100	J	—	—	—	—	—	—	—	
	200	J	FJ2001-3B6B	9000	FJ2003-3B6B	9800	FJ2004-3B6B	16,000	FJ200X-3B6B	19,950
	400	J	FJ4001-3B6B	15,300	FJ4003-3B6B	16,800	FJ4004-3B6B	34,000	FJ400X-3B6B	42,500
	600	J	FJ6001-3B6B	21,100	FJ6003-3B6B	27,000	FJ6004-3B6B	50,300	FJ600X-3B6B	62,800
	800	L	FL8001-3B6B	37,500	FL8003-3B6B	44,100	FL8004-3B6B	65,800	FL800X-3B6B	82,300

NEMA Enclosure type

UL general purpose amp rating	Fuse type	4X Plastic		12		
		Catalog number	List price	Catalog number	List price	
	30	FJ30P-3BB6B	\$ 2250	FJ302-3BB6B	\$ 2150	
	30	FC30P-3BB6B		FC302-3BB6B		
	60	J	—	—	—	
	100	J	—	—	—	
	200	J	FJ200P-3B6B	17,600	FJ2002-3B6B	9800
	400	J	FJ400P-3B6B	33,100	FJ4002-3B6B	16,800
	600	J	FJ600P-3B6B	53,500	FJ6002-3B6B	24,600
	800	L	FL800P-3B6B	73,500	FL8002-3B6B	38,700

Accessories ①②



OESA-ZX157

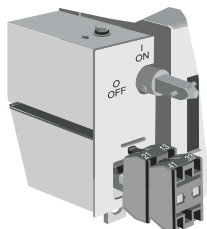

OZXK-1
OZXK-2



3 Position selection switch



Pilot light

Auxiliary contacts

For use on:	Contact configuration	Catalog number	Installation suffix	Installed list price adder
30A	1 N.O. + 1 N. C. 2 N.O. + 2 N.C.	OA4B1C	add "11" suffix add "22" suffix	\$ 70 110
60A – 100A	1 N.O. 1 N.C.	OA1G10 OA3G01	add "10" suffix add "01" suffix	30
200A – 800A	1 N.O. & 1 N.C. 2 N.O. & 2 N.C.	OZXK-1 OZXK-2	add "11" suffix add "22" suffix	130 200

Accessories ①②

For use on:	Description	Installation suffix	Installed list price adder
30A	Neutral block	N	\$ 40
60A – 100A	Neutral block	N	50
200A – 400A	Neutral block	N	150
600A – 800A	Neutral block	N	160
30A – 200A	Service entrance, 3 wire Service entrance, 4 wire	U V	75 125
400A – 800A	Service entrance, 3 wire Service entrance, 4 wire	U V	150 200
30A – 800A	Start/stop pushbuttons 2 position selector switch 3 position selector switch Pilot light "red/run" Ammeter 1 phase ③ Voltmeter ③	A C D E AM VM	68 68 78 110 940 2300

Ground lugs

All enclosed switches are provided with a standard integral ground lug.

Switch size	Ground lug wire size
30 – 100	#14 – 1
200 – 800	#6 – 250 MCM

① Additional accessories can be found on pages 17.83 – 17.95.

② Please consult factory for special customer requirements.

③ Current transformers included.

Technical data

Other configuration descriptions

Disconnect
switches
Fusible
Enclosed

Conversion mechanisms

6 or 8 pole

6 (8) pole mechanism allows two switches controlled by one handle to open or close simultaneously.

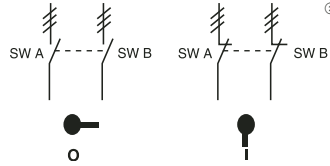

	POS. O	POS. I
SW. A	O	X
SW. B	O	X

X = Closed
O = Open

Transfer^①

Transfer mechanism manually transfers between two power sources using two switches and a center "OFF" position.

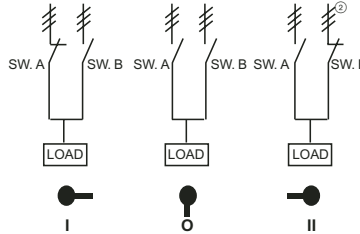

	POS. I	POS.O	POS.II
SW. A	X	O	O
SW. B	O	O	X

X = Closed
O = Open

Bypass^①

Bypass mechanism operates three switches: Two switches in series and one changeover switch to allow power bypass.

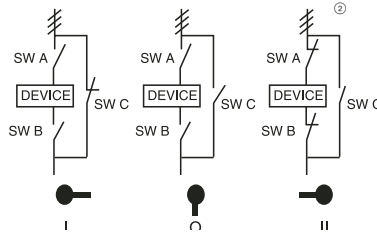

	POS. I	POS.O	POS.II
SW. A	O	O	X
SW. B	O	O	X
SW. C	X	O	O

X = Closed
O = Open

Mechanical interlock

Mechanical interlock mechanism prevents both switches from being in the ON position at the same time.

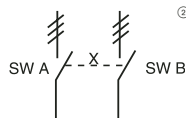

	SW. A POS. I	SW. B POS. O
SW. A	X	O
SW. B	O	X

X = Closed
O = Open

^① Transfer and bypass enclosed switches include the load side bussed or cabled together, and all switches come standard with ground lugs.

^② ≡ = Three poles

Approximate dimensions 2, 3, & 4 Pole ③ 30A – 800A F

Fusible

Frame size	Enclosure type	H height	W width	D depth	MH mtg. height	MW mtg. width	Weight (lbs.)
OS30_	1	10.0	8.0	6.0	7.0	7.0	12
	3R	10.0	8.0	6.0	10.75	6.0	12
	4	10.0	8.0	6.0	10.75	6.0	12
	4X SS	10.0	8.0	6.0	10.75	6.0	12
	4X Plastic	10.0	8.0	5.9	10.75	6.0	8.0
12	10.0	8.0	6.0	10.75	6.0	12	
OS60_	1	10.0	8.0	6.0	7.0	7.0	13
	3R	10.0	8.0	6.0	10.75	6.0	13
	4	10.0	8.0	6.0	10.75	6.0	13
	4X SS	10.0	8.0	6.0	10.75	6.0	13
	4X Plastic	10.0	8.0	5.9	10.75	6.0	9.0
12	10.0	8.0	6.0	10.75	6.0	13	
OS100_	1	14.0	12.0	8.0	11.0	9.0	22
	3R	14.0	12.0	8.0	14.75	10.0	22
	4	14.0	12.0	8.0	14.75	10.0	22
	4X SS	14.0	12.0	8.0	14.75	10.0	22
	4X Plastic	14.0	12.0	8.0	14.75	10.0	16
12	14.0	12.0	8.0	14.75	10.0	22	
OS200_	1	24.0	20.0	10.0	25.5	18.5	75
	3R	24.0	20.0	10.0	25.5	18.5	75
	4	24.0	20.0	10.0	25.5	18.5	75
	4X SS	24.0	20.0	10.0	25.5	18.5	75
	4X Plastic	①	①	①	①	①	①
12	24.0	20.0	10.0	25.5	18.0	75	

Frame size	Enclosure type	H height	W width	D depth	MH mtg. height	MW mtg. width	Weight (lbs.)
OS400_	1	44.0	22.0	11.0	45.5	20.5	150
	3R	44.0	22.0	11.0	49.5	20.5	150
	4	48.0	24.0	12.0	49.5	22.5	150
	4X SS	48.0	24.0	12.0	49.5	22.5	150
	4X Plastic	①	①	①	①	①	①
12	44.0	22.0	11.0	45.5	20.5	150	
OES600_	1	44.0	22.0	11.0	45.5	20.5	150
	3R	44.0	22.0	11.0	49.5	20.5	150
	4	48.0	24.0	12.0	49.5	22.5	150
	4X SS	48.0	24.0	12.0	49.5	22.5	150
	4X Plastic	①	①	①	①	①	①
12	44.0	22.0	11.0	45.5	20.5	150	
OES800_	1	48.0	24.0	12.0	49.5	22.5	170
	3R	48.0	24.0	12.0	49.5	22.5	170
	4	48.0	24.0	12.0	49.5	22.5	170
	4X SS	48.0	24.0	12.0	49.5	22.5	170
	4X Plastic	①	①	①	①	①	①
12	48.0	24.0	12.0	49.5	22.5	170	

- ① Please consult factory, enclosures are sized to suit specific customer needs.
 ② Enclosure is free standing.
 ③ Some 4-pole switches require larger enclosures. Please consult factory.

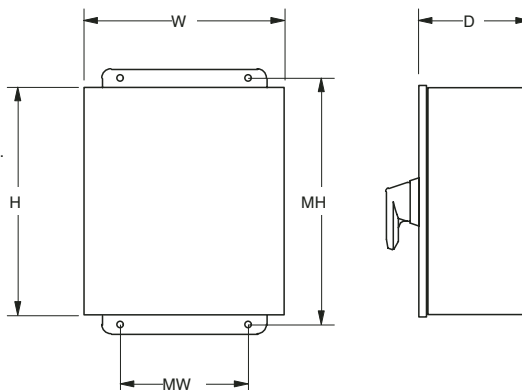

Approximate dimensions for enclosed 6-pole transfer & mechanical interlock switches, 30A – 800A F

Disconnect
switches
Fusible
Enclosed

Fusible

Frame size	Enclosure type	H height	W width	D depth	MH mtg. height	MW mtg. width	Weight (lbs.)
OS30_	1	14.0	12.0	8.0	11.0	9.0	22
	3R	14.0	12.0	8.0	14.75	10.0	22
	4	14.0	12.0	8.0	14.75	10.0	22
	4X SS	14.0	12.0	8.0	14.75	10.0	22
	4X Plastic	14.0	12.0	8.0	14.75	10.0	16
	12	14.0	12.0	8.0	14.75	10.0	22
OS60_	1	20.0	20.0	8.0	21.5	18.5	60
	3R	20.0	20.0	8.0	21.5	18.5	60
	4	20.0	20.0	8.0	21.5	18.5	60
	4X SS	20.0	20.0	8.0	21.5	18.5	60
	4X Plastic	24.0	16.0	10.0	–	–	60
	12	20.0	20.0	8.0	21.5	18.5	60
OS100_	1	20.0	20.0	8.0	21.5	18.5	60
	3R	20.0	20.0	8.0	21.5	18.5	60
	4	20.0	20.0	8.0	21.5	18.5	60
	4X SS	20.0	20.0	8.0	21.5	18.5	60
	4X Plastic	24.0	16.0	10.0	21.5	18.5	60
	12	20.0	20.0	8.0	21.5	18.5	60
OES200_	1	36.0	30.0	12.0	37.5	28.5	100
	3R	36.0	30.0	12.0	37.5	28.5	100
	4	36.0	30.0	12.0	37.5	28.5	100
	4X SS	36.0	30.0	12.0	37.5	28.5	100
	4X Plastic	①	①	①	①	①	①
	12	36.0	30.0	12.0	37.5	28.5	100

① Please consult factory; enclosures can be custom sized to suit specific needs
② Enclosure is free standing.

Frame size	Enclosure type	H height	W width	D depth	MH mtg. height	MW mtg. width	Weight (lbs.)
OES400_	1	48.0	36.0	16.0	49.5	34.5	220
	3R	48.0	36.0	16.0	49.5	34.5	220
	4	48.0	36.0	16.0	49.5	34.5	220
	4X SS	48.0	36.0	16.0	49.5	34.5	220
	4X Plastic	①	①	①	①	①	①
	12	48.0	36.0	16.0	49.5	34.5	220
OES600_	1	48.0	36.0	16.0	49.5	34.5	230
	3R	48.0	36.0	16.0	49.5	34.5	230
	4	48.0	36.0	16.0	49.5	34.5	230
	4X SS	48.0	36.0	16.0	49.5	34.5	230
	4X Plastic	①	①	①	①	①	①
	12	48.0	36.0	16.0	49.5	34.5	230
800A	1	48.0	36.0	16.0	49.5	34.5	230
	3R	48.0	36.0	16.0	49.5	34.5	230
	4	48.0	36.0	16.0	49.5	34.5	230
	4X SS	48.0	36.0	16.0	49.5	34.5	230
	4X Plastic	①	①	①	①	①	①
	12	48.0	36.0	16.0	49.5	34.5	230

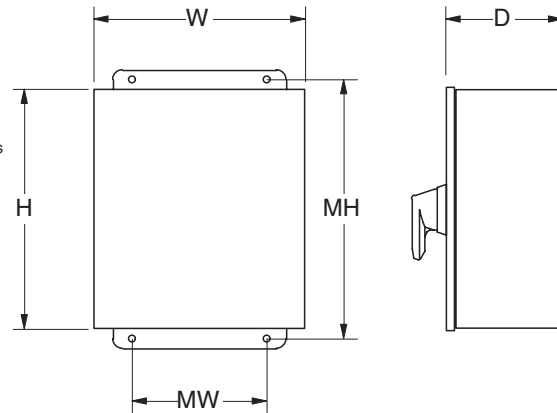

Disconnect
switches
Fusible
Enclosed

Notes
