

Illuminated Extended pushbuttons Momentary

Pilot Devices
Type CBK 22mm



CBK-MPIF6R



CBK-KPIF6R

Illuminated filament bulb, momentary (extended button)

Type	Black plastic ring		Chrome metal ring	
	Catalog number	List price	Catalog number	List price
Operator only¹	CBK-KPI★	\$ 8.10	CBK-MPI★	\$ 8.10
Full voltage type				
6V	CBK-KPIF6★	31.60	CBK-MPIF6★	31.60
12V	CBK-KPIF7★		CBK-MPIF7★	
24V	CBK-KPIF8★		CBK-MPIF8★	
48V	CBK-KPIF9★		CBK-MPIF9★	
120V	CBK-KPIF1★		CBK-MPIF1★	
Resistor type				
120V/60V	CBK-KPIR1★	35.60	CBK-MPIR1★	35.60
240V/120V	CBK-KPIR2★		CBK-MPIR2★	
Transformer type				
120V/6V	CBK-KPIT1★	66.60	CBK-MPIT1★	66.60
240V/6V	CBK-KPIT2★		CBK-MPIT2★	
380V/6V	CBK-KPIT3★		CBK-MPIT3★	
480V/6V	CBK-KPIT4★		CBK-MPIT4★	
120V/24V	CBK-KPIT5★	66.60	CBK-MPIT5★	66.60
240V/24V	CBK-KPIT6★		CBK-MPIT6★	
380V/24V	CBK-KPIT7★		CBK-MPIT7★	
480V/24V	CBK-KPIT8★		CBK-MPIT8★	

★ Substitute the ★ for a suffix letter from the "Illuminated buttons" chart. Example: CBK-KPIF6R
NOTE: If a flush button is desired, add "F" suffix after the ★. Example: CBK-KPIF6RF.

Illuminated LED bulb, momentary (extended button) ²³

Type	Black plastic ring		Chrome metal ring	
	Catalog number	List price	Catalog number	List price
Full voltage type				
24V	CBK-KPIFL8★	\$ 40.60	CBK-MPIFL8★	\$ 40.60
120V	CBK-KPIFL1★	40.60	CBK-MPIFL1★	40.60
240V	CBK-KPIFL2★	46.60	CBK-MPIFL2★	46.60
Transformer type				
120V/24V	CBK-KPITL1★	75.60	CBK-MPITL1★	75.60
240V/24V	CBK-KPITL2★		CBK-MPITL2★	
380V/24V	CBK-KPITL3★	75.60	CBK-MPITL3★	75.60
480V/24V	CBK-KPITL4★		CBK-MPITL4★	

★ Substitute the ★ for a suffix letter from the "Illuminated buttons" chart. Example: CBK-KPIFL8R
NOTE: If a flush button is desired, add "F" suffix after the ★. Example: CBK-KPIFL8RF.

Illuminated neon bulb, momentary (extended button) ⁴

Type	Black plastic ring		Chrome metal ring	
	Catalog number	List price	Catalog number	List price
Full voltage type				
220VAC	CBK-KPIFN2★	\$ 31.60	CBK-MPIFN2★	\$ 31.60

★ Substitute the ★ for a suffix letter from the "Illuminated buttons" chart. Example: CBK-KPIFN1R
NOTE: If a flush button is desired, add "F" suffix after the ★. Example: CBK-KPIFN1RF.

- Lamp module and bulb must be ordered separately; see page 8.34.
- White LEDs use clear lenses.
- For blue or white LED, add \$ 3.00 to list price.
- Use with red, yellow and clear lenses only. For 120VAC, consult factory.

Illuminated Extended pushbuttons Momentary



CBK-CB10



KCB-02

Contact blocks (Maximum 6 per operator)

Item	Separate contact blocks catalog number	Included with operator suffix code	List price adder
1 N.O. 1 N.C.	CBK-CB10 CBK-CB01	10 01	\$ 8.00
1 N.O. & 1N.C. 2 N.O. 2 N.C.	CBK-CB10 + CBK-CB01 CBK-CB10 + CBK-CB10 CBK-CB01 + CBK-CB01	11 20 02	16.00

Pushbuttons are complete except for contact blocks:

- To order a pushbutton operator complete with contact block, add the appropriate suffix code to the end of the catalog number and add the list price adder to the operator list price. EX: CBK-KPIF6R10, **\$ 39.60**
- To order just the contact block, refer to "Separate Contact Blocks" column and indicate catalog number and quantity. EX: CBK-CB10, qty 1, **\$ 8.00**

Example of individual component ordering

$$\begin{array}{r}
 \text{CBK-KPIR} \\
 \$ 8.10
 \end{array}
 + \begin{array}{r}
 \text{Transformer} \\
 \text{(if required)}
 \end{array}
 + \begin{array}{r}
 \text{Lamp module} \\
 \text{CBK-LMF} \\
 \$ 17.50
 \end{array}
 + \begin{array}{r}
 \text{Lamp bulb} \\
 \text{CBK-LB6} \\
 \$ 6.00
 \end{array}
 + \begin{array}{r}
 \text{CBK-CB10} \\
 \$ 8.00
 \end{array}
 = \begin{array}{r}
 \text{CBK-KPIF6R10} \\
 \$ 39.60
 \end{array}$$

5 Contact block holders (Maximum 6 contact blocks)

To order an assembled unit with a 5 contact block holder, add the digit "5" to the end of the catalog number and add \$4.00 to the list price. EX: CBK-KPIF6R5, **\$ 35.60**

To order double contact blocks used with the 5 block holder, order the following combinations separately:

Item	Catalog number	Price
2 NO	KCB-20	\$ 16.00
2 NC	KCB-02	
1 NO & 1 NC	KCB-11	

★ Illuminated buttons

Button color	Suffix code
Red	R
Green	G
Yellow	Y
Blue	L
Clear ①	C
White	W

① To order a lens insert, use the pushbutton with a clear lens and refer to the lens insert selection chart on pages 8.44 - 8.45. Place the appropriate suffix code at the end of the catalog number (but before the contact block suffix code, if there is one) and add \$.90 to the list price.

Illuminated Extended pushbuttons Maintained

Pilot Devices
Type CBK 22mm



CBK-MPIF6R



CBK-KPIF6R

Illuminated, maintained push-push (extended)

Type	Black plastic ring		Chrome metal ring	
	Catalog number	List price	Catalog number	List price
Operator only ①	CBK-KPPI★	\$ 19.30	CBK-MPPI★	\$ 19.30
Full voltage type 6V 12V 24V 48V 120V	CBK-KPPIF6★ CBK-KPPIF7★ CBK-KPPIF8★ CBK-KPPIF9★ CBK-KPPIF1★	42.80	CBK-MPPIF6★ CBK-MPPIF7★ CBK-MPPIF8★ CBK-MPPIF9★ CBK-MPPIF1★	42.80
Resistor type 120V/60V 240V/120V	CBK-KPPIR1★ CBK-KPPIR2★	47.30	CBK-MPPIR1★ CBK-MPPIR2★	47.30
Transformer type 120V/6V 240V/6V 380V/6V 480V/6V	CBK-KPPI1★ CBK-KPPI2★ CBK-KPPI3★ CBK-KPPI4★	78.30	CBK-MPPI1★ CBK-MPPI2★ CBK-MPPI3★ CBK-MPPI4★	78.30
120V/24V 240V/24V 380V/24V 480V/24V	CBK-KPPI5★ CBK-KPPI6★ CBK-KPPI7★ CBK-KPPI8★	78.30	CBK-MPPI5★ CBK-MPPI6★ CBK-MPPI7★ CBK-MPPI8★	78.30

★ Substitute the ★ for a suffix letter from the Illuminated buttons chart. Example: CBK-KPPIF6R
NOTE: If a flush button is desired, add "F" suffix after the ★. Example: CBK-KPPIF6RF.

Illuminated LED bulb, maintained push-push (extended) ②③

Type	Black plastic ring		Chrome metal ring	
	Catalog number	List price	Catalog number	List price
Full voltage type 24V 120V 240V	CBK-KPPIFL8★ CBK-KPPIFL1★ CBK-KPPIFL2★	\$ 51.80 51.80 57.80	CBK-MPPIFL8★ CBK-MPPIFL1★ CBK-MPPIFL2★	\$ 51.80 51.80 57.80
Transformer type 120V/24V 240V/24V 380V/24V 480V/24V	CBK-KPPI1★ CBK-KPPI2★ CBK-KPPI3★ CBK-KPPI4★	86.80	CBK-MPPI1★ CBK-MPPI2★ CBK-MPPI3★ CBK-MPPI4★	86.80

★ Substitute the ★ for a suffix letter from the Illuminated buttons chart. Example: CBK-KPPIFL8R
NOTE: If a flush button is desired, add "F" suffix after the ★. Example: CBK-KPPIFL8RF.

Illuminated neon bulb, maintained push-push (extended) ④

Type	Black plastic ring		Chrome metal ring	
	Catalog number	List price	Catalog number	List price
Full voltage type 220VAC	CBK-KPPIFN2★	\$ 42.80	CBK-MPPIFN2★	\$ 42.80

★ Substitute the ★ for a suffix letter from the Illuminated buttons chart. Example: CBK-KPPIFN1R
NOTE: If a flush button is desired, add "F" suffix after the ★. Example: CBK-KPPIFN2RF.

- ① Lamp module and bulb must be ordered separately; see pages 8.34.
- ② White LEDs use clear lenses.
- ③ For blue or white LED, add \$ 3.00 to list price.
- ④ Use with red, yellow and clear lenses only. For 120VAC, consult factory.

8

Illuminated Extended pushbuttons Maintained



CBK-CB10



KCB-02

Contact blocks (Maximum 6 per operator)

Item	Separate contact blocks catalog number	Included with operator suffix code	List price adder
1 N.O. 1 N.C.	CBK-CB10 CBK-CB01	10 01	\$ 8.00
1 N.O. & 1N.C. 2 N.O. 2 N.C.	CBK-CB10 + CBK-CB01 CBK-CB10 + CBK-CB10 CBK-CB01 + CBK-CB01	11 20 02	16.00

Pushbuttons are complete except for contact blocks:

- To order a pushbutton operator complete with contact block, add the appropriate suffix code to the end of the catalog number and add the list price adder to the operator list price. EX: CBK-KPPIF6R10, **\$ 50.80**
- To order just the contact block, refer to "Separate contact blocks" column and indicate catalog number and quantity. EX: CBK-CB10, qty 1, **\$ 8.00**

Example of individual component ordering

$$\begin{array}{ccccccccccc}
 \text{CBK-KPPIR} & + & \text{Transformer} & + & \text{Lamp module} & + & \text{Lamp bulb} & + & \text{CBK-CB10} & = & \text{CBK-KPPIF6R10} \\
 \$ 19.30 & & \text{(if required)} & & \text{CBK-LMF} & & \text{CBK-LB6} & & & & \\
 & & & & \$ 17.50 & & \$ 6.00 & & \$ 8.00 & & \$ 50.80
 \end{array}$$

5 Contact block holders (Maximum 6 contact blocks)

To order an assembled unit with a 5 contact block holder, add the digit "5" to the end of the catalog number and add \$ 4.00 to the list price. EX: CBK-KPPIF6R5, **\$ 46.80**

To order double contact blocks used with the 5 block holder, order the following combinations separately:

Item	Catalog number	Price
2 NO	KCB-20	\$ 16.00
2 NC	KCB-02	
1 NO & 1 NC	KCB-11	

★ Illuminated buttons

Button color	Suffix code
Red	R
Green	G
Yellow	Y
Blue	L
Clear ①	C
White	W

① To order a lens insert, use the pushbutton with a clear lens and refer to the lens insert selection chart on pages 8.44 - 8.45. Place the appropriate suffix code at the end of the catalog number (but before the contact block suffix code, if there is one) and add \$.90 to the list price.

Illuminated Mushroom pushbuttons, 40mm Maintained



CBK-MPM40IF1Y



CBK-KPM40IF1Y

Illuminated mushrooms, 40mm

Type	Black plastic ring		Chrome metal ring	
	Catalog number	List price	Catalog number	List price
Operator only ①	CBK-KPM40I★	\$ 17.50	CBK-MPM40I★	\$ 17.50
Full voltage type 6V 12V 24V 48V 120V	CBK-KPM40IF6★ CBK-KPM40IF7★ CBK-KPM40IF8★ CBK-KPM40IF9★ CBK-KPM40IF1★	41.00	CBK-MPM40IF6★ CBK-MPM40IF7★ CBK-MPM40IF8★ CBK-MPM40IF9★ CBK-MPM40IF1★	41.00
Resistor type 120V/60V 240V/120V	CBK-KPM40IR1★ CBK-KPM40IR2★	45.00	CBK-MPM40IR1★ CBK-MPM40IR2★	45.00
Transformer type 120V/6V 240V/6V 380V/6V 480V/6V	CBK-KPM40IT1★ CBK-KPM40IT2★ CBK-KPM40IT3★ CBK-KPM40IT4★	76.00	CBK-MPM40IT1★ CBK-MPM40IT2★ CBK-MPM40IT3★ CBK-MPM40IT4★	76.00
120V/6V 240V/6V 380V/6V 480V/6V	CBK-KPM40IT5★ CBK-KPM40IT6★ CBK-KPM40IT7★ CBK-KPM40IT8★	76.00	CBK-MPM40IT5★ CBK-MPM40IT6★ CBK-MPM40IT7★ CBK-MPM40IT8★	76.00

Illuminated mushrooms with LED bulbs, 40mm

Type	Black plastic ring		Chrome metal ring	
	Catalog number	List price	Catalog number	List price
Full voltage type 24V 120V	CBK-KPM40IFL8★ CBK-KPM40IFL1★	\$ 50.00	CBK-MPM40IFL8★ CBK-MPM40IFL1★	\$ 50.00
240V	CBK-KPM40IFL2★	56.00	CBK-MPM40IFL2★	56.00
Transformer type 120V/24V 240V/24V 380V/24V 480V/24V	CBK-KPM40ITL1★ CBK-KPM40ITL2★ CBK-KPM40ITL3★ CBK-KPM40ITL4★	85.00	CBK-MPM40ITL1★ CBK-MPM40ITL2★ CBK-MPM40ITL3★ CBK-MPM40ITL4★	85.00

★ Illuminated buttons

Button color	Suffix code
Red	R
Green	G
Yellow	Y

Contact blocks (Maximum 5 per operator)

Item	Separate contact blocks catalog number	Included with operator suffix code	List price adder
1 N.O. 1 N.C.	CBK-CB10 CBK-CB01	10 01	\$ 8.00
1 N.O. & 1N.C. 2 N.O. 2 N.C.	CBK-CB10 + CBK-CB01 CBK-CB10 + CBK-CB10 CBK-CB01 + CBK-CB01	11 20 02	16.00

Pushbuttons are complete except for contact blocks:

- To order a pushbutton operator complete with contact block, add the appropriate suffix code to the end of the catalog number and add the list price adder to the operator list price. EX: CBK-PM40IF1R10, \$ 49.00
- To order just the contact block, refer to "Separate contact blocks" column and indicate catalog number and quantity. EX: CBK-CB10, qty 1, \$ 8.00

Example of individual component ordering

$$\text{CBK-KPM40IR} \quad \$ 17.50 \quad + \quad \text{Transformer (if required)} \quad + \quad \text{Lamp module CBK-LMF} \quad \$ 17.50 \quad + \quad \text{Lamp bulb CBK-LB1} \quad \$ 6.00 \quad + \quad \text{CBK-CB10} \quad \$ 8.00 \quad = \quad \text{CBK-KPM40IF1R10} \quad \$ 49.00$$

5 Contact block holders (Maximum 5 contact blocks)

To order an assembled unit with a 5 contact block holder, add the digit "5" to the end of the catalog number and add \$ 4.00 to the list price. EX: CBK-KPM40IF1R5, \$ 45.00

To order double contact blocks used with the 5 block holder, order the following combinations separately:

Item	Catalog number	Price
2 NO 2 NC	KCB-20 KCB-02	\$ 16.00
1 NO & 1 NC	KCB-11	

① Lamp module and bulb must be ordered separately; see pages 8.34.

Illuminated Mushroom pushbuttons, 60mm Momentary



CBK-MPM6IF1Y

CBK-KPM6IF1Y

Illuminated mushrooms, 60mm

Type	Black plastic ring		Chrome metal ring	
	Catalog number	List price	Catalog number	List price
Operator only ①	CBK-KPM6I★	\$ 21.50	CBK-MPM6I★	\$ 21.50
Full voltage type 6V 12V 24V 48V 120V	CBK-KPM6IF6★ CBK-KPM6IF7★ CBK-KPM6IF8★ CBK-KPM6IF9★ CBK-KPM6IF1★	45.00	CBK-MPM6IF6★ CBK-MPM6IF7★ CBK-MPM6IF8★ CBK-MPM6IF9★ CBK-MPM6IF1★	45.00
Resistor type 120V/60V 240V/120V	CBK-KPM6IR1★ CBK-KPM6IR2★	49.00	CBK-MPM6IR1★ CBK-MPM6IR2★	49.00
Transformer type 120V/6V 240V/6V 380V/6V 480V/6V	CBK-KPM6IT1★ CBK-KPM6IT2★ CBK-KPM6IT3★ CBK-KPM6IT4★	80.00	CBK-MPM6IT1★ CBK-MPM6IT2★ CBK-MPM6IT3★ CBK-MPM6IT4★	80.00
120V/24V 240V/24V 380V/24V 480V/24V	CBK-KPM6IT5★ CBK-KPM6IT6★ CBK-KPM6IT7★ CBK-KPM6IT8★	80.00	CBK-MPM6IT5★ CBK-MPM6IT6★ CBK-MPM6IT7★ CBK-MPM6IT8★	80.00

★ Select button color from Illuminated Buttons chart and substitute the suffix code for the ★. EX: CBK-PM6IR.

Illuminated mushrooms with LED bulbs, 60mm

Type	Black plastic ring		Chrome metal ring	
	Catalog number	List price	Catalog number	List price
Full voltage type 24V 120V 240V	CBK-KPM6IFL8★ CBK-KPM6IFL1★ CBK-KPM6IFL2★	\$ 54.00 54.00 60.00	CBK-MPM6IFL8★ CBK-MPM6IFL1★ CBK-MPM6IFL2★	\$ 54.00 54.00 60.00
Transformer type 120V/24V 240V/24V 380V/24V 480V/24V	CBK-KPM6ITL1★ CBK-KPM6ITL2★ CBK-KPM6ITL3★ CBK-KPM6ITL4★	89.00	CBK-MPM6ITL1★ CBK-MPM6ITL2★ CBK-MPM6ITL3★ CBK-MPM6ITL4★	89.00

★ Select button color from Illuminated Buttons chart and substitute the suffix code for the ★. EX: CBK-KPM6IR.

★ Illuminated buttons

Button color	Suffix code
Red	R
Green	G
Yellow	Y

Contact blocks (Maximum 5 per operator)

Item	Separate contact blocks catalog number	Included with operator suffix code	List price adder
1 N.O. 1 N.C.	CBK-CB10 CBK-CB01	10 01	\$ 8.00
1 N.O. & 1N.C. 2 N.O. 2 N.C.	CBK-CB10 + CBK-CB01 CBK-CB10 + CBK-CB01 CBK-CB01 + CBK-CB01	11 20 02	16.00

Pushbuttons are complete except for contact blocks:

- To order a pushbutton operator complete with contact block, add the appropriate suffix code to the end of the catalog number and add the list price adder to the operator list price. EX: CBK-KPM6IF1R10, \$ 53.00
- To order just the contact block, refer to "Separate contact blocks" column and indicate catalog number and quantity. EX: CBK-CB10, qty 1, \$ 8.00

Example of individual component ordering

$$\text{CBK-KPM6IR} + \text{Transformer} + \text{CBK-LMF} + \text{Lamp bulb} + \text{CBK-CB10} = \text{CBK-KPM6IF1R10}$$

$$\$ 21.50 + (\text{if required}) + \$ 17.50 + \$ 6.00 + \$ 8.00 = \$ 53.00$$

5 Contact block holders (Maximum 5 contact blocks)

To order an assembled unit with a 5 contact block holder, add the digit "5" to the end of the catalog number and add \$ 4.00 to the list price. EX: CBK-KPM6IF1R5, \$ 49.00

To order double contact blocks used with the 5 block holder, see page 8.21.

① Lamp module and bulb must be ordered separately; see pages 8.34...



CBK-CB10



KCB-02

illuminated Emergency stop pushbuttons, 40mm ①②③④

Pilot Devices
Type CBK 22mm



CBK-EST4IF1R



CBK-ESP4IF1R



CBK-ESCH



CBK-CB10

illuminated emergency stop pushbuttons, 40mm

Type	Twist release		Push-pull	
	Catalog number	List price	Catalog number	List price
Operator only ⑤	CBK-EST4IR	\$ 36.00	CBK-ESP4IR	\$ 36.00
Full voltage type 6V 12V 24V 48V 120V	CBK-EST4IF6R CBK-EST4IF7R CBK-EST4IF8R CBK-EST4IF9R CBK-EST4IF1R	59.50	CBK-ESP4IF6R CBK-ESP4IF7R CBK-ESP4IF8R CBK-ESP4IF9R CBK-ESP4IF1R	59.50
Resistor type 120V/60V 240V/120V	CBK-EST4IR1R CBK-EST4IR2R	63.50	CBK-ESP4IR1R CBK-ESP4IR2R	63.50
Transformer type 120V/6V 240V/6V 380V/6V 480V/6V	CBK-EST4IT1R CBK-EST4IT2R CBK-EST4IT3R CBK-EST4IT4R	94.50	CBK-ESP4IT1R CBK-ESP4IT2R CBK-ESP4IT3R CBK-ESP4IT4R	94.50
120V/24V 240V/24V 380V/24V 480V/24V	CBK-EST4IT5R CBK-EST4IT6R CBK-EST4IT7R CBK-EST4IT8R	94.50	CBK-ESP4IT5R CBK-ESP4IT6R CBK-ESP4IT7R CBK-ESP4IT8R	94.50

8

illuminated emergency stop pushbuttons with LED bulbs, 40mm

Type	Twist release		Push-pull	
	Catalog number	List price	Catalog number	List price
Operator only ⑤ Order lamp module & bulb separately	CBK-EST4IR	\$ 36.00	CBK-ESP4IR	\$ 36.00
Full voltage type 24V 120V 240V	CBK-EST4IFL8R CBK-EST4IFL1R CBK-EST4IFL2R	68.50 68.50 74.50	CBK-ESP4IFL8R CBK-ESP4IFL1R CBK-ESP4IFL2R	68.50 68.50 74.50
Transformer type 120V/24V 240V/24V 380V/24V 480V/24V	CBK-EST4ITL1R CBK-EST4ITL2R CBK-EST4ITL3R CBK-EST4ITL4R	103.50	CBK-ESP4ITL1R CBK-ESP4ITL2R CBK-ESP4ITL3R CBK-ESP4ITL4R	103.50

Contact block holder

Item	Catalog number	List price adder
Contact block holder	CBK-ESCH	\$ 2.00

Contact blocks (Maximum 4 per operator)

Item	Separate contact blocks catalog number	Included with operator suffix code	List price adder
1 N.O. 1 N.C.	CBK-CB10 CBK-CB01	10 01	\$ 8.00
1 N.O. & 1N.C. 2 N.O. 2 N.C.	CBK-CB10 + CBK-CB01 CBK-CB10 + CBK-CB10 CBK-CB01 + CBK-CB01	11 20 02	16.00

Pushbuttons are complete except for contact blocks:

- To order a pushbutton operator complete with contact block, add the appropriate suffix code to the end of the catalog number and add the list price adder to the operator list price. EX: CBK-EST4IF1R01, **\$ 67.50**
- To order just the contact block, refer to "Separate contact blocks" column and indicate catalog number and quantity. EX: CBK-CB01, qty 1, **\$ 8.00**

Example of individual component ordering

$$\text{CBK-EST4IR} + \text{Transformer (if required)} + \text{Lamp module CBK-LMF} + \text{Lamp bulb CBK-LB1} + \text{CBK-CB01} = \text{CBK-EST4IF1R01}$$

$$\$ 36.00 + \text{(if required)} + \$ 17.50 + \$ 6.00 + \$ 8.00 = \$ 67.50$$

- All operators on this page comply with EN418 & IEC947-5-5 standards.
- Use adapter plate described on page 8.53 when using CBK-EP series enclosures.
- See page 8.49 for 30mm adaptor ring. For complete catalog number, please consult factory.
- Cannot use CBK-H5.
- Lamp module and bulb must be ordered separately; see page 8.34.

Illuminated Emergency stop pushbuttons, 60mm ①②③④

8



Illuminated emergency stop pushbuttons, 60mm

Type	Twist release		Push-pull	
	Catalog number	List price	Catalog number	List price
Operator only ⑤	CBK-EST6IR	\$ 48.00	CBK-ESP6IR	\$ 48.00
Full voltage type 6V 12V 24V 48V 120V	CBK-EST6IF6R CBK-EST6IF7R CBK-EST6IF8R CBK-EST6IF9R CBK-EST6IF1R	71.50	CBK-ESP6IF6R CBK-ESP6IF7R CBK-ESP6IF8R CBK-ESP6IF9R CBK-ESP6IF1R	71.50
Resistor type 120V/60V 240V/120V	CBK-EST6IR1R CBK-EST6IR2R	75.50	CBK-ESP6IR1R CBK-ESP6IR2R	75.50
Transformer type 120V/6V 240V/6V 380V/6V 480V/6V	CBK-EST6IT1R CBK-EST6IT2R CBK-EST6IT3R CBK-EST6IT4R	106.50	CBK-ESP6IT1R CBK-ESP6IT2R CBK-ESP6IT3R CBK-ESP6IT4R	106.50
120V/24V 240V/24V 380V/24V 480V/24V	CBK-EST6IT5R CBK-EST6IT6R CBK-EST6IT7R CBK-EST6IT8R	106.50	CBK-ESP6IT5R CBK-ESP6IT6R CBK-ESP6IT7R CBK-ESP6IT8R	106.50

Illuminated emergency stop pushbuttons with LED bulbs, 60mm

Type	Twist release		Push-pull	
	Catalog number	List price	Catalog number	List price
Operator only ⑤ Order lamp module & bulb separately	CBK-EST6IR	\$ 48.00	CBK-ESP6IR	\$ 48.00
Full voltage type 24V 120V 240V	CBK-EST6IFL8R CBK-EST6IFL1R CBK-EST6IFL2R	80.50 80.50 86.50	CBK-ESP6IFL8R CBK-ESP6IFL1R CBK-ESP6IFL2R	80.50 80.50 86.50
Transformer type 120V/24V 240V/24V 380V/24V 480V/24V	CBK-EST6ITL1R CBK-EST6ITL2R CBK-EST6ITL3R CBK-EST6ITL4R	115.50	CBK-ESP6ITL1R CBK-ESP6ITL2R CBK-ESP6ITL3R CBK-ESP6ITL4R	115.50

Contact block holder

Item	Catalog number	List price adder
Contact block holder	CBK-ESCH	\$ 2.00

Contact blocks (Maximum 4 per operator)

Item	Separate contact blocks catalog number	Included with operator suffix code	List price adder
1 N.O. 1 N.C.	CBK-CB10 CBK-CB01	10 01	\$ 8.00
1 N.O. & 1N.C. 2 N.O. 2 N.C.	CBK-CB10 + CBK-CB01 CBK-CB10 + CBK-CB10 CBK-CB01 + CBK-CB01	11 20 02	16.00

Pushbuttons are complete except for contact blocks:

- To order a pushbutton operator complete with contact block, add the appropriate suffix code to the end of the catalog number and add the list price adder to the operator list price. EX: CBK-EST6IF1R01, **\$ 79.50**
- To order just the contact block, refer to "Separate contact blocks" column and indicate catalog number and quantity. EX: CBK-CB01, qty 1, **\$ 8.00**

Example of individual component ordering

$$\begin{array}{ccccccc}
 & & \text{Lamp module} & \text{Lamp bulb} & & & \\
 \text{CBK-EST6IR} & + & \text{Transformer} & + & \text{CBK-LMF} & + & \text{CBK-LB1} & + & \text{CBK-CB01} & = & \text{CBK-EST6IF1R01} \\
 \$ 48.00 & & \text{(if required)} & & \$ 17.50 & & \$ 6.00 & & \$ 8.00 & & \$ 79.50
 \end{array}$$

- ① All operators on this page comply with EN418 & IEC947-5-5 standards.
- ② Use adapter plate described on page 8.52 when using CBK-EP series enclosures.
- ③ See page 8.49 for 30mm adaptor ring. For complete catalog number, please consult factory.
- ④ Can not use CBK-H5.
- ⑤ Lamp module and bulb must be ordered separately; see page 8.34.

Illuminated Two button pushbuttons Momentary

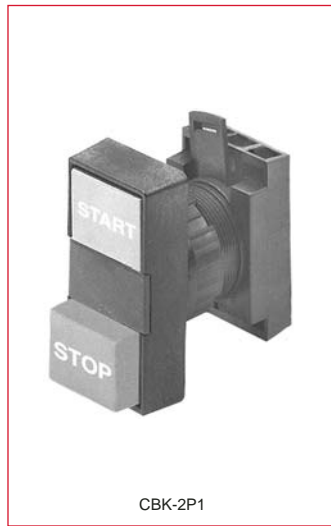

Engraving	Description	Catalog number	List price
On/Off	Flush green & flush red buttons Flush green & extended red buttons Flush white & flush black buttons Flush white & extended black buttons	CBK-2P7★ CBK-2P8★ CBK-2P2★ CBK-2P9★	\$ 31.00
Start/Stop	Flush green & flush red buttons Flush green & extended red buttons Flush white & flush black buttons Flush white & extended black buttons Flush black & extended red buttons	CBK-2P10★ CBK-2P1★ CBK-2P11★ CBK-2P12★ CBK-2P6★	31.00
I/O	Flush green & flush red buttons Flush green & extended red buttons Flush white & flush black buttons Flush white & extended black buttons	CBK-2P3★ CBK-2P13★ CBK-2P14★ CBK-2P15★	31.00
Up / Down	Flush green & flush red buttons	CBK-2P4UD★	31.00
Blank	Flush green & flush red buttons Flush green & extended red buttons Flush white & flush black buttons Flush white & extended black buttons Flush black & extended red buttons Flush black & flush black buttons	CBK-2P4★ CBK-2P16★ CBK-2P5★ CBK-2P17★ CBK-2P18★ CBK-2P20★	28.00



★ Select the catalog number suffix for the lens insert color from "Lens insert colors" chart below.
NOTE: For UL Type 3R, 4, 4X, 12 & 13 applications, use the CBK-XB2 boot. See Accessories, page 8.50 or the chart below.

Lamp modules — operator mounted
See next page.



Lamp bulbs
See next page.

Illuminated Two button pushbuttons Momentary

Lamp modules — operator mounted

Item	Voltage	Catalog number	List price
 CBK-LMF	Full voltage type	CBK-LMF	\$ 17.50
	Resistor type 120V/60V 240V/120V 24V ^② 120V/24V ^③	CBK-LMR1 CBK-LMR2 CBK-LMR24 CBK-LMLED	21.50
 CBK-LT1	Transformer type 120V/6V 240V/6V 380V/6V 480V/6V 120V/24V 240V/24V 380V/24V 480V/24V	CBK-LT1 CBK-LT2 CBK-LT3 CBK-LT4 CBK-LT124 CBK-LT224 CBK-LT324 CBK-LT424	35.00

Lamp bulbs

Item	Voltage	Catalog number	List price
Filament  Neon  CBK-LB6 CBK-LBN1	Filament 6 VAC/DC 12 VAC/DC 24 VAC/DC 30 VAC/DC 48 VAC/DC 60 VAC/DC 130 VAC/DC Neon ^④ 220 VAC	CBK-LB6 CBK-LB12 CBK-LB24 CBK-LB30 CBK-LB48 CBK-LB60 CBK-LB1 CBK-LBN2	\$ 6
LED bulbs	Standard Red 12 VDC 24 VAC/DC 48 VAC/VDC 60VAC/VDC 110-130 VAC/DC 120 VAC 230 VAC Green 12 VDC 24 VAC/DC 48 VAC/VDC 60VAC/VDC 110-130 VAC/DC 120 VAC 230 VAC Yellow 12 VDC 24 VAC/DC 48 VAC/VDC 60VAC/VDC 110-130 VAC/DC 120 VAC 230 VAC Blue 12 VDC 24 VAC/DC 48 VAC/VDC 60VAC/VDC 110-130 VAC/DC 120 VAC 230 VAC White 12 VDC 24 VAC/DC 48 VAC/VDC 60VAC/VDC 110-130 VAC/DC 120 VAC 230 VAC Flashing Red 24 VDC Green 24 VDC Yellow 24 VDC	CBK-LBD12R CBK-LBD8R CBK-LBD48R CBK-LBD60R CBK-LBD13R CBK-LBD1R CBK-LBD2R CBK-LBD12G CBK-LBD8G CBK-LBD48G CBK-LBD60G CBK-LBD13G CBK-LBD1G CBK-LBD2G CBK-LBD12Y CBK-LBD8Y CBK-LBD48Y CBK-LBD60Y CBK-LBD13Y CBK-LBD1Y CBK-LBD2Y CBK-LBD12L CBK-LBD8L CBK-LBD48L CBK-LBD60L CBK-LBD13L CBK-LBD1L CBK-LBD2L CBK-LBD12W CBK-LBD8W CBK-LBD48W CBK-LBD60W CBK-LBD13W CBK-LBD1W CBK-LBD2W CBK-LBDRF CBK-LBDGF CBK-LBDYF	\$ 27 15 21 21 21 15 21 27 15 21 21 21 15 21 32 18 21 21 28 18 24 32 18 21 21 28 18 24 20
 CBK-LBD1R			

8

★ Lens insert colors

Color	Catalog. no. suffix	Catalog number	List price
Green	G	CBK-2LG	\$ 2.40
Red	R	CBK-2LR	
Yellow	Y	CBK-2LY	
Clear	C	CBK-2LC	

Protective boot

Item	Catalog number	List price
Flush boot for two button operator	CBK-XB2	\$ 8

① Price includes operator only. Lamp modules, lamp bulbs, transformers and contact blocks must be ordered separately from the above tables. Two button pushbuttons are complete except for lamp modules, lamp bulbs, transformers and contact blocks which should be ordered as separate components. EX: To order a start/stop operator with a red 120V full voltage pilot light:

• CBK-2PIR	\$ 31.00	• CBK-LB1	\$ 6.00
• CBK-LMF	17.50	• CBK-CB10	8.00
• CBK-LB1	6.00	• CBK-CB01	8.00
TOTAL		TOTAL	\$ 70.50

② Designed for electronic circuits. The resistor limits the making current and prevents disturbances in the circuit. 24V filament lamp bulb required.

③ Designed for LED 24V bulbs.

④ Use with red, yellow and clear lenses only. For 120VAC, consult factory.

Illuminated Press-to-test pushbuttons

Pilot Devices
Type CBK 22mm

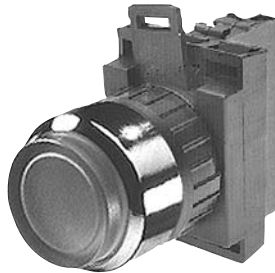

CBK-MLFPT1Y



CBK-MLTPT1Y

Press-to-test

Type	Black plastic ring		Chrome metal ring	
	Catalog number	List price	Catalog number	List price
Operator only ①	CBK-KLPT★	\$ 22.50	CBK-MLPT★	\$ 22.50
Full voltage type 6V 12V 24V 48V 120V	CBK-KLFPT6★ CBK-KLFPT7★ CBK-KLFPT8★ CBK-KLFPT9★ CBK-KLFPT1★	46.00	CBK-MLFPT6★ CBK-MLFPT7★ CBK-MLFPT8★ CBK-MLFPT9★ CBK-MLFPT1★	46.00
Resistor type 120V 240V	CBK-KLRPT1★ CBK-KLRPT2★	54.00	CBK-MLRPT1★ CBK-MLRPT2★	54.00
Transformer type 120V/6V 240V/6V 380V/6V 480V/6V	CBK-KLTPT1★ CBK-KLTPT2★ CBK-KLTPT3★ CBK-KLTPT4★	80.00	CBK-MLTPT1★ CBK-MLTPT2★ CBK-MLTPT3★ CBK-MLTPT4★	80.00
120V/24V 240V/24V 380V/24V 480V/24V	CBK-KLTPT5★ CBK-KLTPT6★ CBK-KLTPT7★ CBK-KLTPT8★	80.00	CBK-MLTPT5★ CBK-MLTPT6★ CBK-MLTPT7★ CBK-MLTPT8★	80.00

★ Select the lens color from the "Illuminated buttons & lenses" selection chart and substitute the suffix code for the ★. The lens and bulb are included in the price.

Press-to-test (LED bulb) ②

Type	Black plastic ring		Chrome metal ring	
	Catalog number	List price	Catalog number	List price
Full voltage type 24V 120V 230V	CBK-KLFPTL8★ CBK-KLFPTL1★ CBK-KLFPTL2★	\$ 55.00 55.00 61.00	CBK-MLFPTL8★ CBK-MLFPTL1★ CBK-MLFPTL2★	\$ 55.00 55.00 61.00
Transformer type 120V/24V 240V/24V 380V/24V 480V/24V	CBK-KLTPTL1★ CBK-KLTPTL2★ CBK-KLTPTL3★ CBK-KLTPTL4★	80.00	CBK-MLTPTL1★ CBK-MLTPTL2★ CBK-MLTPTL3★ CBK-MLTPTL4★	80.00

★ Select the lens color from the "Illuminated buttons & lenses" selection chart and substitute the suffix code for the ★. The lens and bulb are included in the price.

Press-to-test (neon bulb) ③

Item	Black plastic ring		Chrome metal ring	
	Catalog number	List price	Catalog number	List price
Full voltage type 220VAC	CBK-KLTPN2★	\$ 46.00	CBK-MLTPN2★	\$ 46.00

★ Illuminated buttons

Button color	Suffix code
Red	R
Green	G
Yellow	Y
Blue	L
Clear	C
White	W

NOTE: White LEDs use clear lenses.

Schematic

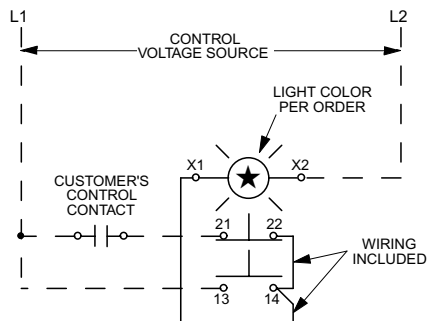

Press-to-test schematic

① 1 N.O. & 1 N.C. contact supplied; lamp module and bulb must be ordered separately.

② For blue or white LEDs, add \$ 3 to the list price.

③ Use with red, yellow and clear lenses only. For 120VAC, consult factory.

Illuminated Selector switches 2 position



CBK-M2BMKIY



CBK-2BMLIY



CBK-CB10



KCB-02

Knob operator — 2 position^①

Type		Black plastic ring		Chrome metal ring			
		Catalog number	List price	Catalog number	List price		
Translucent knob operator							
Maintained	Clear Red Green Yellow Blue	CBK-2BMKIC CBK-2BMKIR CBK-2BMKIG CBK-2BMKIY CBK-2BMKIL	\$ 19.00	CBK-M2BMKIC CBK-M2BMKIR CBK-M2BMKIG CBK-M2BMKIY CBK-M2BMKIL	\$ 19.00		
Momentary	Clear Red Green Yellow Blue	CBK-2BSKIC CBK-2BSKIR CBK-2BSKIG CBK-2BSKIY CBK-2BSKIL		28.00		CBK-M2BSKIC CBK-M2BSKIR CBK-M2BSKIG CBK-M2BSKIY CBK-M2BSKIL	28.00
Maintained	Clear Red Green Yellow Blue	CBK-2AMKIC CBK-2AMKIR CBK-2AMKIG CBK-2AMKIY CBK-2AMKIL				19.00	

Lever operator — 2 position^①

Type		Black plastic ring		Chrome metal ring			
		Catalog number	List price	Catalog number	List price		
Translucent lever operator							
Maintained	Clear Red Green Yellow Blue	CBK-2BMLIC CBK-2BMLIR CBK-2BMLIG CBK-2BMLIY CBK-2BMLIL	\$ 19.00	CBK-M2BMLIC CBK-M2BMLIR CBK-M2BMLIG CBK-M2BMLIY CBK-M2BMLIL	\$ 19.00		
Momentary	Clear Red Green Yellow Blue	CBK-2BSLIC CBK-2BSLIR CBK-2BSLIG CBK-2BSLIY CBK-2BSLIL		28.00		CBK-M2BSLIC CBK-M2BSLIR CBK-M2BSLIG CBK-M2BSLIY CBK-M2BSLIL	28.00
Maintained	Clear Red Green Yellow Blue	CBK-2AMLIC CBK-2AMLIR CBK-2AMLIG CBK-2AMLIY CBK-2AMLIL				19.00	

Contact blocks (Maximum 4 per operator)

Item	Separate contact blocks catalog number	Included with operator suffix code	List price adder
1 N.O. 1 N.C.	CBK-CB10 CBK-CB01	10 01	\$ 8.00
1 N.O. & 1 N.C. 2 N.O. 2 N.C.	CBK-CB10 + CBK-CB01 CBK-CB10 + CBK-CB10 CBK-CB01 + CBK-CB01	11 20 02	16.00

Illuminated selector switches are complete except for lamp modules, lamp bulbs, and contact blocks which should be ordered as separate components. EX: To order a knob selector switch operator with a red 120V full voltage light and 2 N.O. contact blocks:

- CBK-2BMKIR **\$ 19.00**
- CBK-LMF **17.50**
- CBK-LB1 **6.00**
- (2) CBK-CB10 **16.00**

TOTAL \$ 58.50

5 Contact block holders (Maximum 4 contact blocks)

To order an assembled unit with a 5 contact block holder, add the digit "5" to the end of the catalog number and add \$ 4.00 to the list price. EX: CBK-2BMKIR5, **\$ 23.00**

To order double contact blocks used with the 5 block holder, order the following combinations separately:

Item	Catalog number	Price
2 NO	KCB-20	\$ 16.00
2 NC	KCB-02	
1 NO & 1 NC	KCB-11	

Selector switch contacts

2 Position

As viewed from the front, the contacts are in the normal position with the switch handle in either the "A" or "B" position. In the "C" position, the contact(s) change state.

① Lamp module and bulb must be ordered separately; see pages 8.34.

ILLUMINATED Selector switches 3 position



Knob operator — 3 position ①

Type		Black plastic ring		Chrome metal ring	
		Catalog number	List price	Catalog number	List price
Translucent knob operator					
Maintained A B C	Clear Red Green Yellow Blue	CBK-3MKIC CBK-3MKIR CBK-3MKIG CBK-3MKIY CBK-3MKIL	\$ 19.00	CBK-M3MKIC CBK-M3MKIR CBK-M3MKIG CBK-M3MKIY CBK-M3MKIL	\$ 19.00
Momentary return from A & C position A B C	Clear Red Green Yellow Blue	CBK-3SKIC CBK-3SKIR CBK-3SKIG CBK-3SKIY CBK-3SKIL	28.00	CBK-M3SKIC CBK-M3SKIR CBK-M3SKIG CBK-M3SKIY CBK-M3SKIL	28.00
Momentary return from C position A B C	Clear Red Green Yellow Blue	CBK-3SRKIC CBK-3SRKIR CBK-3SRKIG CBK-3SRKIY CBK-3SRKIL	28.00	CBK-M3SRKIC CBK-M3SRKIR CBK-M3SRKIG CBK-M3SRKIY CBK-M3SRKIL	28.00
Momentary return from A position A B C	Clear Red Green Yellow Blue	CBK-3SLKIC CBK-3SLKIR CBK-3SLKIG CBK-3SLKIY CBK-3SLKIL	28.00	CBK-M3SLKIC CBK-M3SLKIR CBK-M3SLKIG CBK-M3SLKIY CBK-M3SLKIL	28.00

Lever operator — 3 position ①

Type		Black plastic ring		Chrome metal ring	
		Catalog number	List price	Catalog number	List price
Translucent lever operator					
Maintained A B C	Clear Red Green Yellow Blue	CBK-3MLIC CBK-3MLIR CBK-3MLIG CBK-3MLIY CBK-3MLIL	\$ 19.00	CBK-M3MLIC CBK-M3MLIR CBK-M3MLIG CBK-M3MLIY CBK-M3MLIL	\$ 19.00
Momentary return from A & C position A B C	Clear Red Green Yellow Blue	CBK-3SLIC CBK-3SLIR CBK-3SLIG CBK-3SLIY CBK-3SLIL	28.00	CBK-M3SLIC CBK-M3SLIR CBK-M3SLIG CBK-M3SLIY CBK-M3SLIL	28.00
Momentary return from C position A B C	Clear Red Green Yellow Blue	CBK-3SRLIC CBK-3SRLIR CBK-3SRLIG CBK-3SRLIY CBK-3SRLIL	28.00	CBK-M3SRLIC CBK-M3SRLIR CBK-M3SRLIG CBK-M3SRLIY CBK-M3SRLIL	28.00
Momentary return from A position A B C	Clear Red Green Yellow Blue	CBK-3SLLIC CBK-3SLLIR CBK-3SLLIG CBK-3SLLIY CBK-3SLLIL	28.00	CBK-M3SLLIC CBK-M3SLLIR CBK-M3SLLIG CBK-M3SLLIY CBK-M3SLLIL	28.00

Selector switch contacts 3 Position

As viewed from the front, the contact(s) are in the normal position with the switch handle in the "B" position. In the "A" position, the left contact(s) change state. In the "C" position, the right contact(s) change state.

Contact blocks (Maximum 4 per operator)

Item	Separate contact blocks catalog number	Assembled to operator suffix code	List adder
1N.O. 1N.C.	CBK-CB10 CBK-CB01	10 01	\$ 8.00
1 N.O. & 1 N.C. 2 N.O. 2 N.C.	CBK-CB10 + CBK-CB01 CBK-CB10 + CBK-CB10 CBK-CB01 + CBK-CB01	11 20 02	16.00

Illuminated selector switches are complete except for lamp modules, lamp bulbs, and contact blocks which should be ordered as separate components.
EX: To order a knob selector switch operator with a red 120V full voltage light and 2 N.O. contact blocks:

- CBK-3MKIR \$ 19.00
- CBK-LMF 17.50
- CBK-LB1 6.00
- (2) CBK-CB10 16.00

TOTAL \$ 58.50

5 Contact block holders (Maximum 4 contact blocks)



To order an assembled unit with a 5 contact block holder, add the digit "5" to the end of the catalog number and add \$ 4.00 to the list price.

EX: CBK-2BMKIR5, \$ 23.00

① Lamp module and bulb must be ordered separately; see pages 8.38.



Illuminated Selector switches Components

Lamp modules — operator mounted

Item	Voltage	Catalog number	List price
 CBK-LMF	Full voltage type	CBK-LMF	\$ 17.50
	Resistor type 120V/60V 240V/120V 24V ^① 120V/24V ^②	CBK-LMR1 CBK-LMR2 CBK-LMR24 CBK-LMLEDD	21.50
 CBK-LT1	Transformer type ^④ 120V/6V 240V/6V 380V/6V 480V/6V 120V/24V 240V/24V 380V/24V 480V/24V	CBK-LT1 CBK-LT2 CBK-LT3 CBK-LT4 CBK-LT124 CBK-LT224 CBK-LT324 CBK-LT424	35.00

NOTE: Illuminated selector switch operators are complete except for lamp bulbs, lamp modules & contact blocks; these should be ordered separately from the above.

Lamp bulbs





Item	Voltage	Catalog number	List price
Filament Neon   CBK-LB6 CBK-LBN1	Filament 6 VAC/DC 12 VAC/DC 24 VAC/DC 30 VAC/DC 48 VAC/DC 60 VAC/DC 130 VAC/DC Neon ^③ 220 VAC	CBK-LB6 CBK-LB12 CBK-LB24 CBK-LB30 CBK-LB48 CBK-LB60 CBK-LB1 CBK-LBN2	\$ 6
LED bulbs  CBK-LBD1R	Standard Red 12 VDC 24 VAC/DC 48 VAC/VDC 60VAC/VDC 110-130 VAC/DC 120 VAC 230 VAC Green 12 VDC 24 VAC/DC 48 VAC/VDC 60VAC/VDC 110-130 VAC/DC 120 VAC 230 VAC Yellow 12 VDC 24 VAC/DC 48 VAC/VDC 60VAC/VDC 110-130 VAC/DC 120 VAC 230 VAC Blue 12 VDC 24 VAC/DC 48 VAC/VDC 60VAC/VDC 110-130 VAC/DC 120 VAC 230 VAC White 12 VDC 24 VAC/DC 48 VAC/VDC 60VAC/VDC 110-130 VAC/DC 120 VAC 230 VAC Flashing Red 24 VDC Green 24 VDC Yellow 24 VDC	CBK-LBD12R CBK-LBD8R CBK-LBD48R CBK-LBD60R CBK-LBD13R CBK-LBD1R CBK-LBD2R CBK-LBD12G CBK-LBD8G CBK-LBD48G CBK-LBD60G CBK-LBD13G CBK-LBD1G CBK-LBD2G CBK-LBD12Y CBK-LBD8Y CBK-LBD48Y CBK-LBD60Y CBK-LBD13Y CBK-LBD1Y CBK-LBD2Y CBK-LBD12L CBK-LBD8L CBK-LBD48L CBK-LBD60L CBK-LBD13L CBK-LBD1L CBK-LBD2L CBK-LBD12W CBK-LBD8W CBK-LBD48W CBK-LBD60W CBK-LBD13W CBK-LBD1W CBK-LBD2W CBK-LBDRF CBK-LBDGF CBK-LBDYF	27 15 21 21 21 15 21 27 15 21 21 21 15 21 27 15 21 21 21 21 15 21 32 18 21 21 28 18 24 32 18 21 21 28 18 24 20

① Designed for electronic circuits. The resistor limits the making current and prevents disturbances in the circuit. 24V filament lamp bulb required.
 ② Designed for LED 24V bulbs.
 ③ Use with red, yellow and clear lenses only. For 120VAC, consult factory.
 ④ Mounts on CBK-LMF

Standard pilot lights

Pilot Devices
Type CBK 22mm

Standard pilot lights

Item	Voltage	Catalog number	List price
Incandescent bulb			
	Operator only	CBK-KLF★ ^①	\$ 6.50
	Full voltage type 6V 12V 24V 48V 120V	CBK-KLF6★ CBK-KLF7★ CBK-KLF8★ CBK-KLF9★ CBK-KLF1★	30.00
	Resistor type 120V/60V 240V/120V	CBK-KLR1★ CBK-KLR2★	34.00
	Transformer type 120V/6V 240V/6V 380V/6V 480V/6V	CBK-KLT1★ CBK-KLT2★ CBK-KLT3★ CBK-KLT4★	65.00
	120V/24V 240V/24V 380V/24V 480V/24V	CBK-KLT5★ CBK-KLT6★ CBK-KLT7★ CBK-KLT8★	65.00
LED bulb			
	Full voltage type 24V 120V 230V	CBK-KLFL8★ CBK-KLFL1★ CBK-KLFL2★	\$ 39.00 39.00 45.00
	Transformer type		
	120V/24V 240V/24V 380V/24V 480V/24V	CBK-KLTL1★ CBK-KLTL2★ CBK-KLTL3★ CBK-KLTL4★	74.00
Neon bulb ^③			
	Full voltage type 220VAC	CBK-KLFN2★	34.00

★ Select the lens color from the Illuminated Buttons & Lenses selection chart and substitute the suffix code for the ★. The lens and bulb are included in the price.



① Lamp module and bulb must be ordered separately; see page 8.38.

② For blue or white LED add \$ 3.00 to list price.

③ Use with red, yellow, and clear lenses only. For 120VAC, consult factory.

④ To order a lens insert, refer to the lens insert selection chart on pages 8.44 - 8.45 and place the appropriate suffix code at the end of the catalog number (but before the contact block suffix code, if there is one) and add \$.90 to the list price.

Lamp bulbs

Item	Voltage	Catalog number	List price
Filament			
	6 VAC/DC 12 VAC/DC 24 VAC/DC 30 VAC/DC 48 VAC/DC 60 VAC/DC 130 VAC/DC	CBK-LB6 CBK-LB12 CBK-LB24 CBK-LB30 CBK-LB48 CBK-LB60 CBK-LB1	\$ 6
	Neon ^② 220 VAC	CBK-LBN2	
LED bulbs			
Standard			
Red			
	12 VDC 24 VAC/DC 48 VAC/VDC 60VAC/VDC 110-130 VAC/DC 120 VAC 230 VAC	CBK-LBD12R CBK-LBD8R CBK-LBD48R CBK-LBD60R CBK-LBD13R CBK-LBD1R CBK-LBD2R	27 15 21 21 21 15 21
Green			
	12 VDC 24 VAC/DC 48 VAC/VDC 60VAC/VDC 110-130 VAC/DC 120 VAC 230 VAC	CBK-LBD12G CBK-LBD8G CBK-LBD48G CBK-LBD60G CBK-LBD13G CBK-LBD1G CBK-LBD2G	27 15 21 21 21 15 21
Yellow			
	12 VDC 24 VAC/DC 48 VAC/VDC 60VAC/VDC 110-130 VAC/DC 120 VAC 230 VAC	CBK-LBD12Y CBK-LBD8Y CBK-LBD48Y CBK-LBD60Y CBK-LBD13Y CBK-LBD1Y CBK-LBD2Y	27 15 21 21 21 15 21
Blue			
	12 VDC 24 VAC/DC 48 VAC/VDC 60VAC/VDC 110-130 VAC/DC 120 VAC 230 VAC	CBK-LBD12L CBK-LBD8L CBK-LBD48L CBK-LBD60L CBK-LBD13L CBK-LBD1L CBK-LBD2L	32 18 21 21 28 18 24
White			
	12 VDC 24 VAC/DC 48 VAC/VDC 60VAC/VDC 110-130 VAC/DC 120 VAC 230 VAC	CBK-LBD12W CBK-LBD8W CBK-LBD48W CBK-LBD60W CBK-LBD13W CBK-LBD1W CBK-LBD2W	32 18 21 21 28 18 24
Flashing			
	Red 24 VDC Green 24 VDC Yellow 24 VDC	CBK-LBDRF CBK-LBDGF CBK-LBDYF	20

★ Illuminated buttons and lenses

	Color	Suffix code
	Red	R
	Green	G
	Yellow	Y
	Blue	L
	Clear ^②	C
	White	W

NOTE: White LEDs come with clear lenses.