



COMPACT PLUG IN STYLE RELAY

B/W Series 5400 Relays were developed especially for use as safe, reliable, economical original equipment components in many different types of commercial and industrial products.

Designed to operate from electrodes or probes contacting conductive liquids, they are ideally suited to level control applications in such products as vending, dispensing, ice-making machines, water softeners, dishwashers, and coffee makers, plus many type of operating equipment in the food, drug, dairy, brewing, distilling and chemical processing industries.

In addition, Series 5400 Relays have a low energy sensing circuit with a lock-in holding feature that permits operation over a range of levels, or from momentary contact pilot devices such as float, actuators, etc. Thus they are equally suitable for use as original equipment components in many products and systems that require monitoring and control of such process variable as temperature, pressure, humidity, flow, voltage and current, etc.

OTHER FEATURES AND ADVANTAGES

- UL Recognized Component File No. E61377
- CUL File No. LR 33434
- Choice of direct or inverse operation to provide fail-safe control. In *direct* operation, load relay is *energized* when the low voltage ac sensing circuit is completed. In *inverse* operation, load relay is *de-energized* when the low voltage ac sensing circuit is completed.
- LED indicates when relay is energized.
- Relays will operate reliably when mounted in any position required to meet a complete range of application design requirements.
- Relays will operate over ambient temperature range from $-10^{\circ} + 131^{\circ}F$ (-23° to $55^{\circ}C$).
- User adjustable sensing resistance.
- Rugged octal plug-in housing.
- Heavy-duty internal construction.
- Made in the USA.

BASIC SPECIFICATIONS

- Voltage:** 120 volts ac, 50/60 hertz
240 volts ac, 50/60 hertz
24 volts ac, 50/60 hertz (special order)
- Power Required:** 1.2 volt-amperes max.
- Load Contacts:** Single pole, double throw.
Silver Cadmium Oxide
- Contact Ratings:** 10 amps resistive load or 1/3 hp at 120 volts
- Sensing Voltage:** 18 VAC RMS max.
- Sensing Current:** 2.0 mA RMS max.
- Sensitivity:** Adjustable 1K to 250K ohms +/- 10%. Factory set at 100k OHMS +/- 10%.
- Mounting:** 8 pin octal base socket (sold separately)
- Time Delay:** 5 seconds +/- 10%, other delay times available on 5400-A and 5400-B series only.

NOTE: All line voltage circuits are isolated from the low voltage ac sensing circuit to assure optimum safety in service.

DISCONNECT POWER BEFORE SERVICING

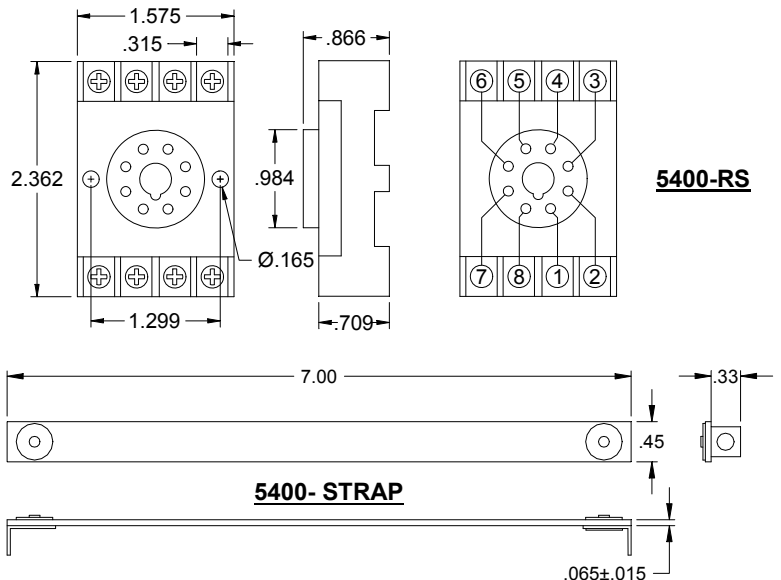
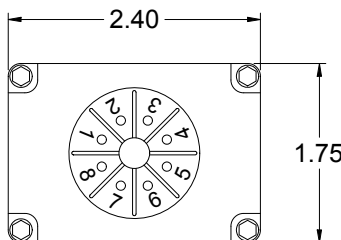
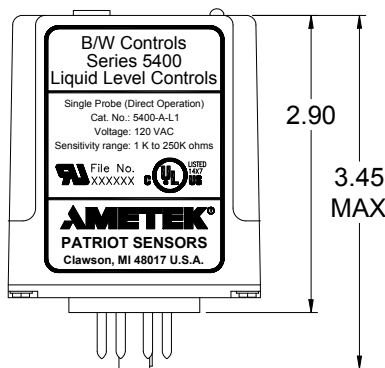

Series 5400 Relay Dimensions

TYPICAL APPLICATIONS

Diagrams at right illustrate basic details of typical application in which Series 5400 Relays are used as original equipment components to provide fail-safe control by de-energizing the load in event of power of relay failure.

In **Diagram 1**, Type 5400-C Relay is used in *direct* operation to provide automatic *pump down* control for dehumidifiers, sumps or any other product requiring control of a liquid at a given high-level set point.

In **Diagram 2**, Type 5400-D Relay is used in *inverse* operation to provide *pump-up* control for carbonators, humidifiers, purification stills, etc. where liquid must be kept above a low level set point.

In **Diagram 3**, Type 5400-A Relay is used in *direct* operation to provide high-level alarm.

In **Diagram 4**, Type 5400-B Relay is used in *inverse* operation to provide low-level alarm.

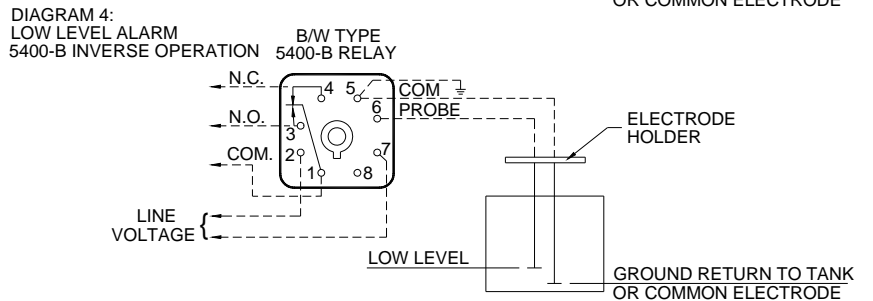
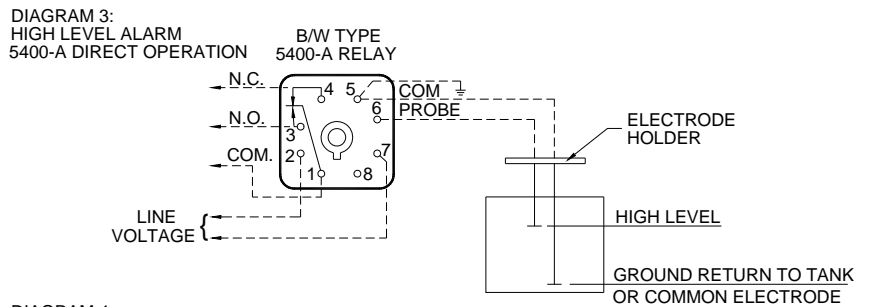
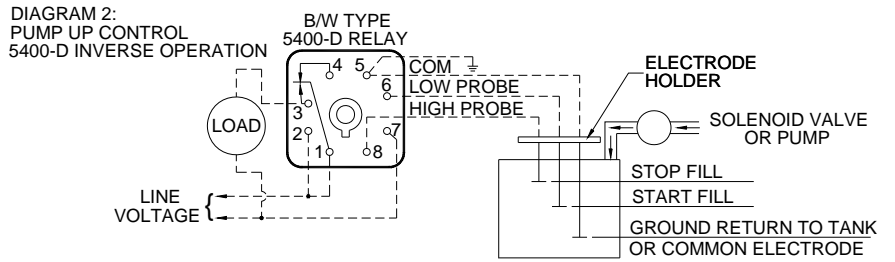
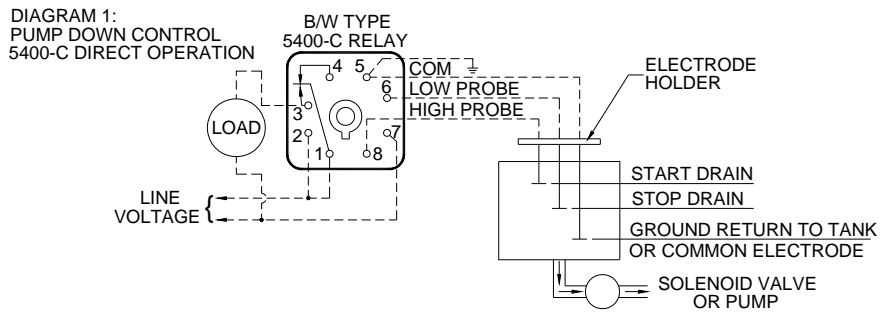

ACCESSORIES

The 5400 relays require a standard 8 pin octal base for mounting. In addition a hold down strap is also available to secure the 5400 the relay to the octal base in vibration environments.

INSTALLATION NOTES

Because Series 5400 Relays feature a low voltage, low current sensing circuit, inexpensive small gauge lead wires may be used between relays and electrodes, sensors, or pilot switching devices. Shielded cable is not required, and lead wires do not have to be isolated from other wiring. Also, in many level control applications, a common electrode is not required so long as a good, dependable metallic ground return from the relay to the liquid is provided. The length of the control wires, between the electrodes and the Series 5400, are dependent on two factors, the control wire configuration and the sensitivity setting, see reference chart to the right.

	Telephone Pair	Two #14 in open air	Two #14 in ½" conduit	Two #14 in lead sheath
Minimum (1.0K ohms Sensitivity)	In excess of 50,000 feet	In excess of 50,000 feet	In excess of 50,000 feet	8,000 feet
Maximum (250k ohms Sensitivity)	700 feet	530 feet	265 feet	35 feet

Ordering Information

	SINGLE LEVEL		DUAL LEVEL	
	Direct Operation (High Level Alarm)	Inverse Operation (Low Level Alarm)	Direct Operation (Pump Down)	Inverse Operation (Pump Up)
110 Volts A.C.	5400-A-L1	5400-B-L1	5400-C-L1	5400-D-L1
220 Volts A.C.	5400-A-L2	5400-B-L2	5400-C-L2	5400-D-L2



1080 North Crooks Road • Clawson, MI 48017 USA
800-635-0289 • 248-435-0700 • Fax 248-435-8120
www.ametek.com

5400.B1R
11/02 • Z118
1M