

Warranty, Service & Repair

To register your product with the manufacturer, fill out the enclosed warranty card and return it immediately to:

Flowline Inc.
10500 Humbolt Street
Los Alamitos, CA 90720.

If for some reason your product must be returned for factory service, contact Flowline Inc. to receive a Material Return Authorization number (MRA) first, providing the following information:

1. Part Number, Serial Number
2. Name and telephone number of someone who can answer technical questions related to the product and its application.
3. Return Shipping Address
4. Brief Description of the Symptom
5. Brief Description of the Application

Once you have received a Material Return Authorization number, ship the product prepaid in its original packing to:

Flowline Factory Service
MRA _____
10500 Humbolt Street
Los Alamitos, CA 90720

To avoid delays in processing your repair, write the MRA on the shipping label. Please include the information about the malfunction with your product. This information enables our service technicians to process your repair order as quickly as possible.

FLOWLINE®

Switch-Tek™ Powered Level Switches LZ12, LU10, LP15, LP10, and LO10 Series Owner's Manual



Version 1.6A

© 2005 FLOWLINE Inc.

All rights reserved.

Manual # LO900002 - 0208-PS1M1_6A

WARRANTY

Flowline warrants to the original purchaser of its products that such products will be free from defects in material and workmanship under normal use and service for a period which is equal to the shorter of one year from the date of purchase of such products or two years from the date of manufacture of such products.

This warranty covers only those components of the products which are non-moving and not subject to normal wear. Moreover, products which are modified or altered, and electrical cables which are cut to length during installation are not covered by this warranty.

Flowline's obligation under this warranty is solely and exclusively limited to the repair or replacement, at Flowline's option, of the products (or components thereof) which Flowline's examination proves to its satisfaction to be defective. FLOWLINE SHALL HAVE NO OBLIGATION FOR CONSEQUENTIAL DAMAGES TO PERSONAL OR REAL PROPERTY, OR FOR INJURY TO ANY PERSON.

This warranty does not apply to products which have been subject to electrical or chemical damage due to improper use, accident, negligence, abuse or misuse. Abuse shall be assumed when indicated by electrical damage to relays, reed switches or other components. The warranty does not apply to products which are damaged during shipment back to Flowline's factory or designated service center or are returned without the original casing on the products. Moreover, this warranty becomes immediately null and void if anyone other than service personnel authorized by Flowline attempts to repair the defec-

tive products.

Products which are thought to be defective must be shipped prepaid and insured to Flowline's factory or a designated service center (the identity and address of which will be provided upon request) within 30 days of the discovery of the defect. Such defective products must be accompanied by proof of the date of purchase.

Flowline further reserves the right to unilaterally wave this warranty and to dispose of any product returned to Flowline where:

- a. There is evidence of a potentially hazardous material present with product.
- b. The product has remained unclaimed at Flowline for longer than 30 days after dutifully requesting disposition of the product.

THERE ARE NO WARRANTIES WHICH EXTEND BEYOND THE DESCRIPTION ON THE FACE OF THIS WARRANTY. This warranty and the obligations and liabilities of Flowline under it are exclusive and instead of, and the original purchaser hereby waives, all other remedies, warranties, guarantees or liabilities, express or implied. EXCLUDED FROM THIS WARRANTY IS THE IMPLIED WARRANTY OF FITNESS OF THE PRODUCTS FOR A PARTICULAR PURPOSE OR USE AND THE IMPLIED WARRANTY OF MERCHANT ABILITY OF THE PRODUCTS.

This warranty may not be extended, altered or varied except by a written instrument signed by a duly-authorized officer of Flowline, Inc.

SPECIFICATIONS

Step One

Common Specifications:

Orientation:	Universal
Accuracy:	± 1 mm in water
Repeatability:	± 0.5 mm in water
Supply voltage:	12-36 VDC
	12-30 VDC (LZ12 Only)
Consumption:	25 mA maximum
Contact type:	(1) SPST relay
Contact rating:	60VA
Contact output:	Selectable NO/NC
Process temp.:	F: -40° to 176° C: -40° to 80°
Pressure:	150 psi (10 bar) @ 25° C., derated @ 1.667 psi (.113 bar) per °C. above 25° C.
Sensor rating:	NEMA 6 (IP68): PP NEMA 4X (IP65): PFA
Cable type:	4-conductor, #22 AWG (shielded)
Cable length:	Standard: 10' (3m) Special order: 25' (7.6m) or 50' (15.2m)
Process mount:	3/4" NPT (3/4" G / Rp)
Mount. gasket:	Viton® (G version only)
Classification:	General purpose
CE compliance:	EN 61326 EMC EN 61010-1 safety

LP15 Specifications:

Dielectric range:	> 20 constants
Conductive range:	> 100 micromhos
Sensor material:	PP
Cable jacket mat.:	PP

LO10 Specifications:

Sensor material:	1__5: PP 2__5: PFA
Cable jacket mat.:	1__5: PP 2__5: PFA

LZ12 Specifications:

Maint. alarm:	NPN transistor 10 mA max.
Sensor material:	Ryton® (glass fill) Viton® cable grommet
Process temp.:	F: -40° to 176° C: -40° to 80°
Cable jacket mat.:	PP
Cable type:	5-conductor, #24 AWG (shielded)

LU10 Specifications:

Sensor material:	1__5: PP 2__5: PFA
Cable jacket mat.:	1__5: PP 2__5: PFA
Classification:	Intrinsically safe
Approvals:	CSA: Class I, Groups A, B, C & D; Class II, Groups E, F and G; Class III EEx: Class 1, Division 1, Groups A, B, C, D; EEx ib IIC T6
Parameters:	CSA: Vmax = 32V, Imax = 300 mA, Pmax = 1.3 W Ci = 0 µF, Li = 0 µH EEx: Ui = 32V; li = 300 mA; Pi = 1.3 W; Ci = 0 µF; Li = 0 µH
Certificates:	CSA: LR 79326 EEx: LCIE 01.E6048 X

LP10 Specifications:

Dielectric range:	> 20 constants
Conductive range:	> 100 micromhos
Sensor material:	1__5: PP 2__5: PFA
Cable jacket mat.:	1__5: PP 2__5: PFA

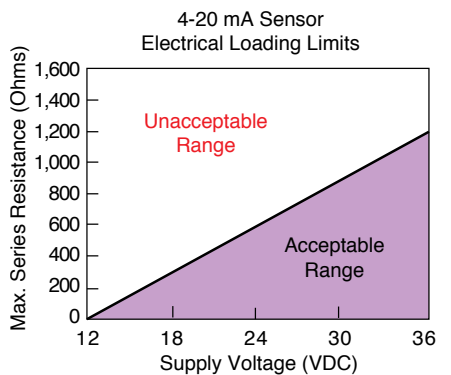
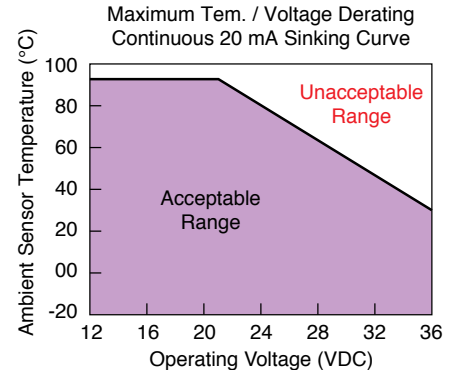
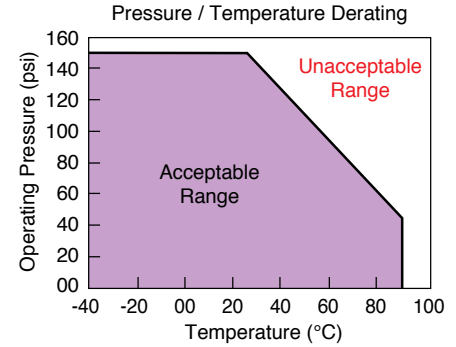

Note: The TFA Teflon sensors are designed so the sensing tips can be submersed in the process liquid, but the cable must not be submersed.

Table of Common Dielectric Constants

NOTE: Liquids with a dielectric constant less than 20 will not be detected by an LP15 or LP10 series level switch, as factory calibrated.

Acetone	21	Chlorotoluene	4.7	Ethylene chloride	10.5	Isobutyl methyl ketone	25	Trichloroethylene	3.4
Acetaldehyde	22.2	Chloroform	4.5 to 5.0	Ethyl acetate	6.4		13	Trichloroacetic acid	4.5
Acetyl methyl hexyl ketone	28	Chlorine, liquid	2.0	Ethyl salicylate	8.6	Jet fuel	1.7	Oils, vegetable	2.5 to 3.5
Alcohol	16 to 31	Carbon tetrachloride	2.2	Ethyl stearate	2.9	Lead carbonate	18	Oils, mineral	2.3 to 2.4
Ammonia	15 to 25	Cyan	2.6	Ethyl silicote	4.1	Lead nitrate	38	Oils, petroleum	1.5 to 1.7
Acetic acid	4.1 to 6.2	Cyclohexane	2.2	Formic acid	59	Methyl salicylate	9.0	Thinner	3.7
Butyl chloride	9.6	D.I. Water	20	Freon	2.2	Methanol	33	Urea	3.5
Barium chloride	9 to 11	Ethyl toluene	2.2	Glycerine	47	Methyl alcohol	33 to 38	Vinyl chloride	2.8 to 6
Benzene	2.3	Ethyl alcohol	23	Glycol	30	Margarine, liquid	2.8 to 3.2	Vinyl alcohol	1.8 to 2.0
Benzine	2.3	Ethylene glycol	37	Glycol nitrite	27			Water, 20°C	80
Barium nitrate	5.6	Ethylene oxide	14	Gasoline	2 to 2.2	Methyl acetate	7.3	Water, 100°C	48
Bromine	3.1	Ethylene dichloride	11 to 17	Hydrochloric acid	4.6	N-butyl formate	2.4		
Chlorobenzene	4.7 to 6			Isobutyric acid	2.7	Nitrobenzene	26 to 35		
								Potassium nitrate	5.0 to 5.9
								Potassium chloride	5.0
								Stearic acid	2.3
								Toluene	2.4

DIMENSIONS

Step Two

Switch-Tek™ Vibration Level Switch, LZ12 Series

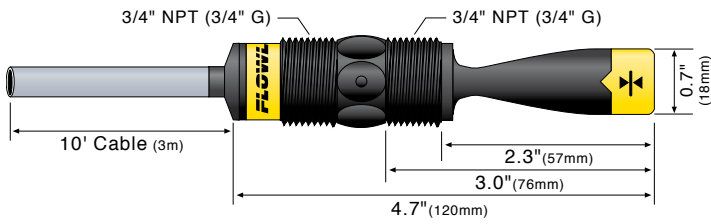

Switch-Tek™ Ultrasonic Level Switch, LU10 Series

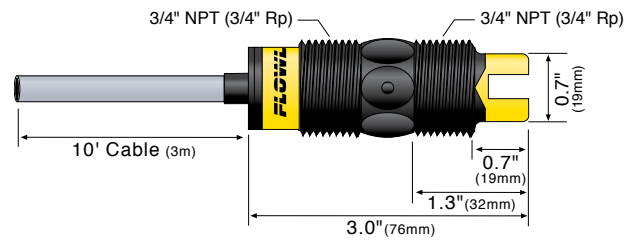
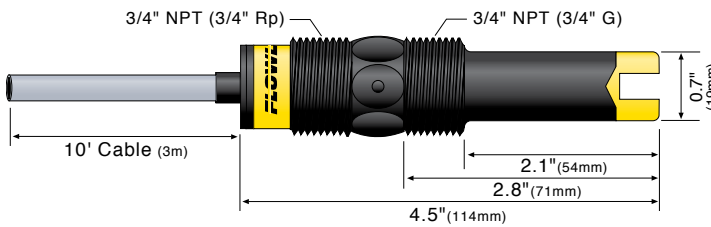

Switch-Tek™ SuperGuard RF Capacitance Level Switch, LP15 Series

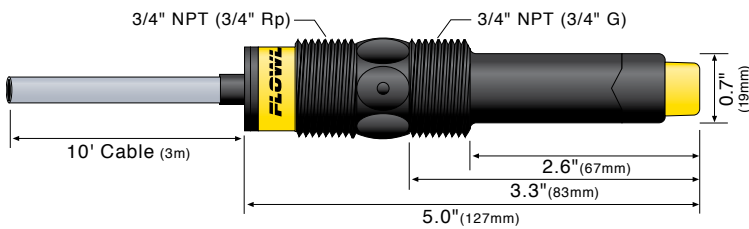

Switch-Tek™ Intrusive RF Capacitance Level Switch, LP10 Series

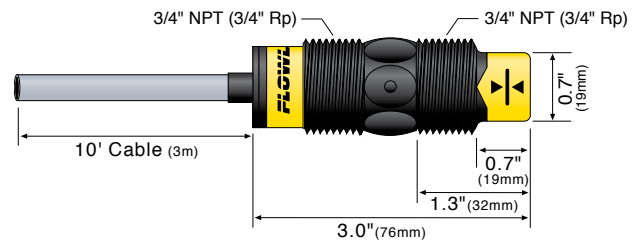
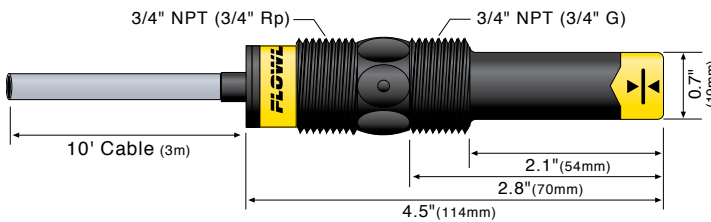

Switch-Tek™ Optic Leak Detection Switch, LO10 Series

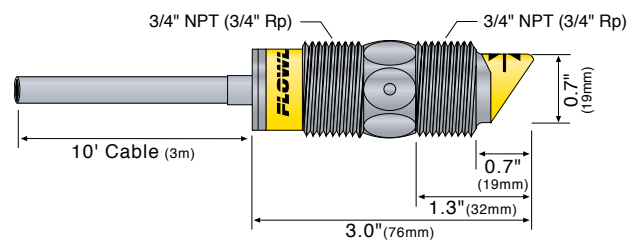
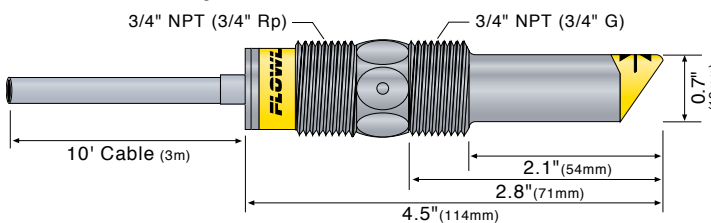

* all dimensions are Nominal

SAFETY PRECAUTIONS

Step Three

About this Manual:

PLEASE READ THE ENTIRE MANUAL PRIOR TO INSTALLING OR USING THIS PRODUCT. This manual includes information on all models of Flowline Switch-Tek™ Powered Level Switches: LZ12, LU10, LP15, LP10 and LO10 series. Please refer to the part number located on the switch label to verify the exact model which you have purchased.

User's Responsibility for Safety:

Flowline manufactures a wide range of liquid level sensors and technologies. While each of these sensors is designed to operate in a wide variety of applications, it is the user's responsibility to select a sensor model that is appropriate for the application, install it properly, perform tests of the installed system, and maintain all components. The failure to do so could result in property damage or serious injury.

Proper Installation and Handling:

Because this is an electrically operated device, only properly-trained staff should install and/or repair this product. Use a proper sealant with all installations. *Note: Always install the 3/4" Viton gasket with all versions of Switch-Tek™ with metric threads. The G threaded version will not seal unless the gasket is properly installed.* Never overtighten the sensor within the fitting, beyond a maximum of 80 inch-pounds torque. Always check for leaks prior to system start-up.

Material Compatibility:

The LU10, LP10 and LO10 series sensors are available in two different wetted materials. Models L_10-1__5 are made of Polypropylene(PP). Models L_10-2__5 are made of Perfluoroalkoxy(PFA). The LZ12 series is made of Ryton® (40% glass filled) and the LP15 series is made of PP. Make sure that the model you have selected is compatible with the application liquid. To determine the chemical compatibility between the sensor and its application liquids, refer to an industry reference such as the Compass Corrosion Guide (available from Compass Publications, phone 858-589-9636).

Wiring and Electrical:

The supply voltage used to power the sensor should never exceed a maximum of 36 volts DC (30 VDC for LZ12 series). Electrical wiring of the sensor should be performed in accordance with all applicable national, state, and local codes.

Flammable, Explosive and Hazardous Applications:

Only the LU10-__5 series switch is rated for use in hazardous locations. Refer to the Certificate of Compliance for all applicable intrinsically safe ratings and entity parameters. Refer to the National Electric Code (NEC) for all applicable installation requirements in hazardous locations. **DO NOT USE THE LZ12, LP15, LP10 OR LO10 SERIES GENERAL PURPOSE SWITCH IN HAZARDOUS LOCATIONS.**

WARNING

The rating for the relay is 60 VA.

Flowline's Switch-Tek™ level switches are not recommended for use with electrically charged application liquids. For most reliable operation, the liquid being measured may need to be electrically grounded.

Always install the 3/4" Viton gasket with all versions of the powered sensors with metric threads. The G threaded version will not seal unless the gasket is installed properly.

INTRODUCTION

Step Four

Vibration Switch:

The Tuning Fork vibration switch operates at a nominal frequency of 400 Hz. As the switch becomes immersed in a liquid or slurry, a corresponding frequency shift occurs. When the measured frequency shift reaches the set point value, the switch changes state indicating the presence of a liquid or slurry medium. For optimum performance and proactive maintenance, the sensor automatically adjusts for coating, and if necessary, outputs a preventative maintenance alarm.

 ***Do not squeeze the forks together. Doing so could damage or break the sensor and void the warranty.***

When powering up the LZ12, the start-up procedure requires the switch to cycle through a wet condition for 1/2 second in order to determine an initial resonance.

Ultrasonic Switch:

The Ultrasonic level switch generates a 1.5 MHz ultrasonic wave from a miniature piezoelectric transducer located on one side of the gap in its sensing tip. Another piezo transducer located on the other side of the gap acts as a microphone, picking up the sound. When liquid enters the gap in the sensing tip, the audio level changes.

 ***The sensor should be installed so that the liquid will drip out of the gap when the sensor becomes dry.***

Optic Switch:

The Optic Leak Detector use principles of optical refraction to detect the presence or absence of fluid. A pulsed infrared light beam is internally generated by a light emitting diode and aimed at the slanted optical tip of the sensor. If the tip is dry, the light beam bounces at a 90 degree angle to a receiving photo transistor, indicating a dry condition. If the tip is immersed in liquid, the light beam will refract out into the liquid instead of being reflected to the photo transistor, indicating a wet condition.

 ***The Optic Leak Detector can not detect the presence or absence of specular application liquids that reflect light (such as milk), or viscous liquids (such as paint) that form a coating on the sensor tip.***

SuperGuard Capacitance Switch:

The SuperGuard level switch generates a pulse-wave radio frequency signal from the capacitance electrode located in the sensing tip of each sensor. When liquid comes into contact with the sensing tip, the capacitance as measured by the sensor changes based on the dielectric constant of the liquid. The guard circuit rejects the negative effects of coating buildup on the probe by eliminating the coating signal path between the active and reference electrodes.

Intrusive RF Capacitance Switch:

The Intrusive RF Capacitance level switch generates a 300 kHz pulse-wave radio frequency signal from the capacitance electrode located in the sensing tip of each sensor. When liquid comes into contact with the sensing tip, the capacitance as measured by the sensor changes based on the dielectric constant of the liquid.

 ***The sensor's operation may vary based on the dielectric properties of various application liquids. The LP15 & LP10 series sensor is factory-calibrated to be used with liquids with a dielectric value between 20 and 80. Liquids with a dielectric constant less than 20 will not be detected by an LP15 & LP10 series sensor, as factory calibrated.***

INSTALLATION

Step Five

Through Wall Installation:

Flowline's Switch-Tek™ level switches may be installed through the top, side or bottom of a tank wall. The sensor has male 3/4" NPT threads on either side of a 15/16" wrench flat. This enables the user to select the sensor's mounting orientation, installed outside of the tank in, or inside of the tank out.

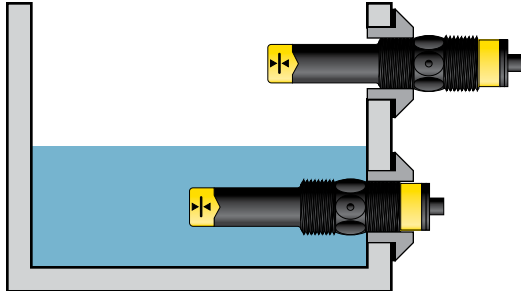

Always install the 3/4" Viton gasket with the metric (long sensor length) versions of the L__-__2__. The G threaded version of the Switch-Tek™ will not seal unless the gasket is installed properly.

Smart Trak™ Installation:

Flowline's Smart Trak LM10 series mounting system is an in-tank fitting which enables users to install up to four FLOWLINE sensors of any technology, to any depth, along the entire length of track. Smart Trak may be installed through the top wall of any tank using a standard 2" NPT tank adapter. If no tank top installation is available, Flowline's side mount bracket, LM50-1001, enables Smart Trak to be installed directly to the side wall of a tank. *Do not use PFA Teflon sensors with Smart-Trak.*

Switch Pak™ Installation:

Flowline's Switch Pak LM45 series mounting system is an in-tank fitting which enables users to install one FLOWLINE sensor, of any technology, to a specific depth. The Flowline sensor may be installed onto the 3/4" NPT adapter at the end of the Switch Pak. Switch Pak may be installed through the top wall of any tank using a standard 2" NPT tank adapter. Flowline's side mount bracket, model LM50-1001, may also be used if top wall installation is not available.

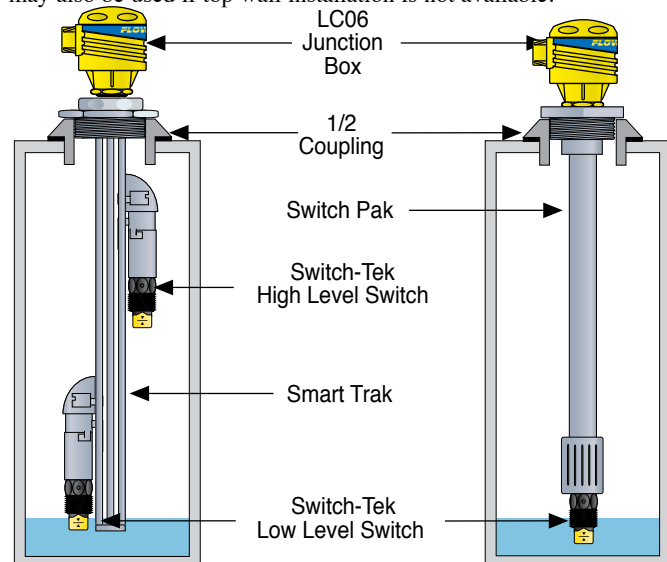

ELECTRICAL

Step Six

Supply Voltage:

The supply voltage to the Switch-Tek™ level switch should never exceed a maximum of 36 VDC. Flowline controllers have a built-in 13.5 VDC power supply which provides power to all of Flowline's electrically powered sensors. Alternative controllers and power supplies, with a minimum output of 12 VDC up to a maximum output of 36 VDC, may also be used with the Switch-Tek™ level switch.

Required Cable Length:

Determine the length of cable required between the Switch-Tek™ level switch and its point of termination. Allow enough slack to ensure the easy installation, removal and/or maintenance of the sensor. The cable length may be extended up to a maximum of 1000 feet, using a well-insulated, 14 to 20 gauge shielded four conductor cable.

Wire Stripping:

Using a 10 gauge wire stripper, carefully remove the outer layer of insulation from the last 1-1/4" of the sensor's cable. Unwrap and discard the exposed foil shield from around the signal wires, leaving the drain wire attached if desired. With a 20 gauge wire stripper, remove the last 1/4" of the colored insulation from the signal wires.

Signal Outputs (Current sensing):

The standard method used by Flowline controllers; this technology uses only two wires (Red and Black). The sensor draws 5 mA when it is dry, and 19 mA when wet. NC/NO status must be set by the controller. The White and Green wires are not used.

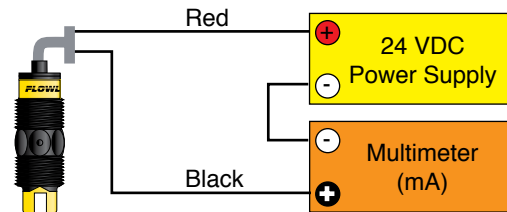

Signal Output (Relay switching):

Allows the sensor to switch a small load on or off directly, using an internal 1A relay (60 VAC/60 VDC). Only model LU10-__5 uses the relay and features 4 wires (red, black, white and green) and a shield wire. The NO/NC status is set by the polarity of the voltage feeding the red and black wires. The green wire is the common for the relay and the white wire is the NO or NC, depending on the polarity of red and black.

Normally Open Wiring:

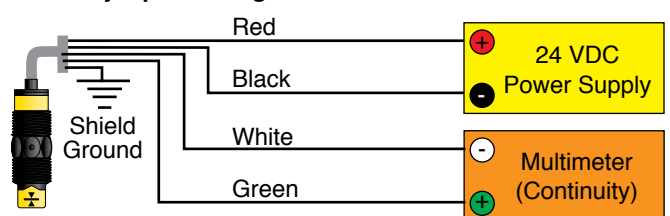

Normally Closed Wiring:

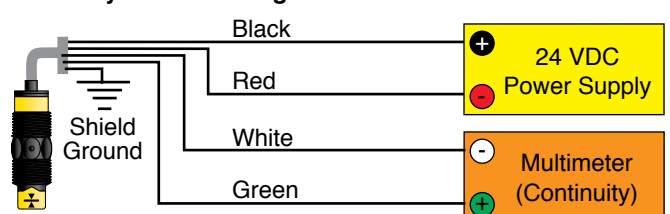

WIRING

Step Seven

Wiring to a Flowline Controller: LC10 Series Controller

(4 or 20 mA signal output)

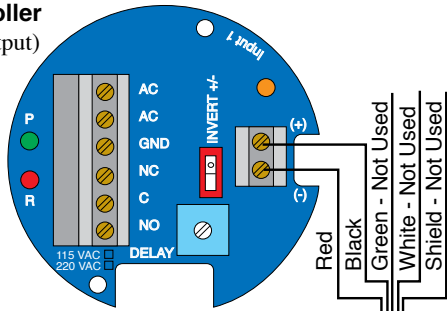

LC40 Series Controller

(4 or 20 mA signal output)

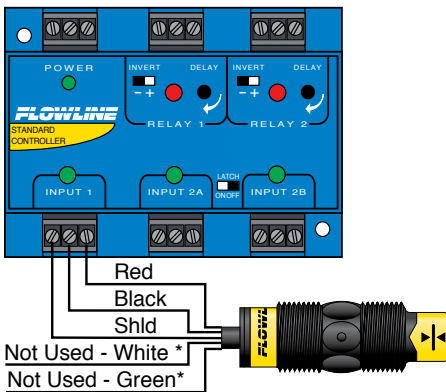

Maintenance Alarm (LZ12 Vibration only):

For optimum performance and proactive maintenance, the sensor automatically adjusts for coating, and if necessary, outputs a preventative maintenance alarm. The Yellow wire is a NPN transistor designed to switch when a build-up of material prevents the vibration switch from operating at its operational frequency. Use the Yellow wire to identify when the Vibration switch requires cleaning.

To wire the maintenance output wire to an LED, follow the wiring diagram below. The Yellow wire is connected to the LED and a 2.2kΩ resistor in series and referenced back to the (+) of the power supply.

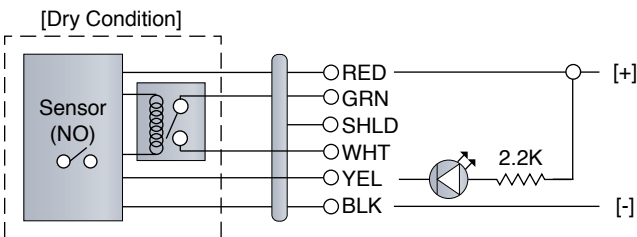

To wire the maintenance output wire to a PLC, follow the wiring diagram below. The Yellow wire is connected to the PLC input with a 10 kΩ resistor parallel to the PLC input and the (+) of the power supply.

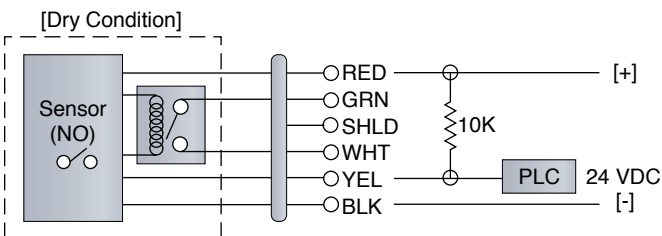

WIRING

Step Eight

Wiring the Relay Output:

The Switch-Tek™ relay output can be wired as a dry contact to a VDC or VAC power source. Switch-Tek™ does require 12 - 36 VDC power to operate the sensor and switch the relay. All illustrations below identify a Dry switch state as the normal position of the relay.

Switching a Normally Open DC Load:

The Red wire connects to Positive (+) of the power supply and the Black wire connects to Negative (-). The LOAD can be attached to either the Green or White wires. Complete the circuit by either connecting the Green to (+) VDC power or White to (-) VDC power (see illustration below).

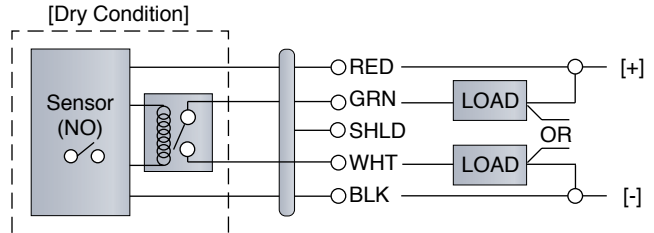

Switching a Normally Closed DC Load:

The Black wire connects to Positive (+) of the power supply and the Red wire connects to Negative (-). The LOAD can be attached to either the Green or White wires. Complete the circuit by either connecting the Green to (+) VDC power or White to (-) VDC power (see illustration below).

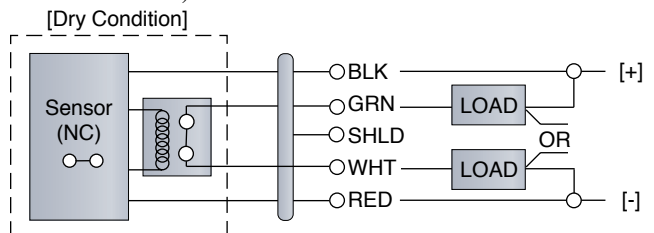

Switching a Normally Open AC Load:

The Red wire connects to Positive (+) of the DC power supply and the Black wire connects to Negative (-). The LOAD can be attached to the Green wire and the Hot of the VAC power. Connect the White to the Neutral of the VAC power (see illustration below).

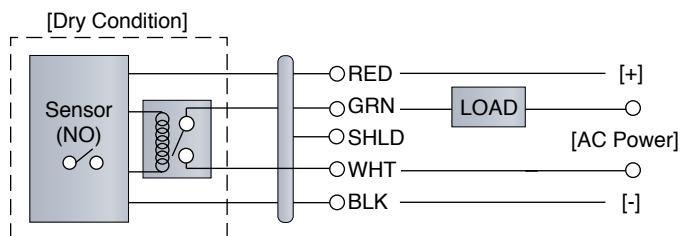

Switching a Normally Closed AC Load:

The Black wire connects to Positive (+) of the DC power supply and the Red wire connects to Negative (-). The LOAD can be attached to the Green wire and the Hot of the VAC power. Connect the White to the Neutral of the VAC power (see illustration below).

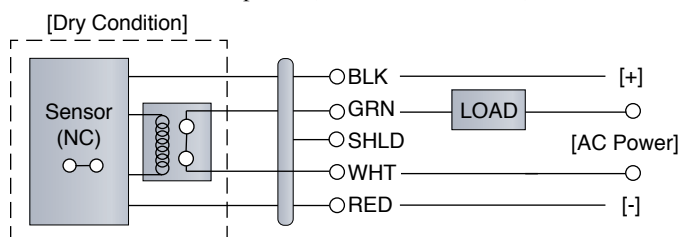

WIRING

Step Nine

Models LU10-___5 Only:

The LU10-___5 level switch has been approved for use in Class I, Groups A, B, C & D; UNDER CERTIFICATE NUMBER LR 79326-4. DO NOT USE THE LZ12, LP15, LP10 or LO10 SERIES IN INTRINSICALLY SAFE APPLICATIONS. The Entity parameter for the LU10-___5 are:

$$\begin{aligned} V_{max} &= 32 \text{ VDC} \\ I_{max} &= 0.5 \text{ A} \\ C_i &= 0 \mu\text{F} \\ L_i &= 0 \text{ mH} \end{aligned}$$

Intrinsically Safe Control Drawing:

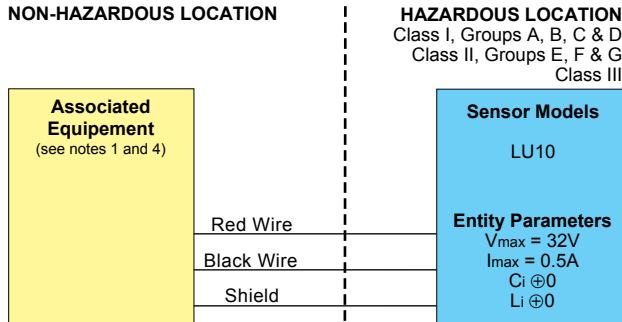

Notes:

1. CSA certified associated equipment with entity parameters.
2. $V_{max} \geq V_{oc}$, $I_{max} \geq I_{sc}$, $C_i + C_{cable} \geq C_a$, $L_i + L_{cable} \geq L_a$.
3. Installation should be in accordance with CEC Part I, or NFPA 70.
4. Associated equipment must be installed per manufacturers instructions

Sensor Drawing: LSD1
Rev. B 10-01-02

Wiring to a Flowline Controller: LC90 Series Controller 4 or 20 mA Signal Output

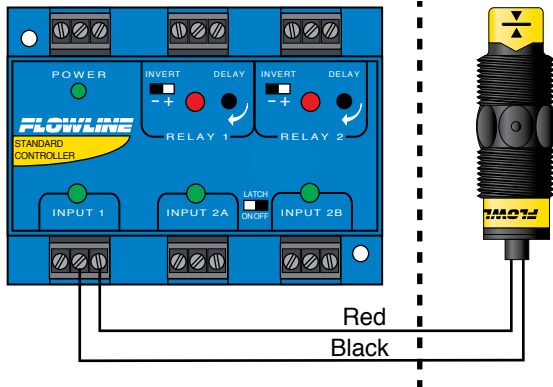

$$\begin{aligned} V_{oc} &= 17.47 \text{ VDC} & V_{max} &= 32 \text{ VDC} \\ I_{sc} &= 0.4597 \text{ A} & I_{max} &= 0.5 \text{ A} \\ C_a &= 0.494 \mu\text{F} & C_i &= 0 \mu\text{F} \\ L_a &= 0.119 \mu\text{H} & L_i &= 0 \mu\text{H} \end{aligned}$$

WIRING

Step Ten

Models LU10-___5 Only:

The LU10-___5 level switch has been approved for use in Class I, Division 1, Groups A, B, C & D; EEx ib IIC T6; UNDER CERTIFICATE NUMBER LCIE 01.E6048X. DO NOT USE THE LZ12, LP15, LP10 or LO10 SERIES IN INTRINSICALLY SAFE APPLICATIONS. The Entity parameter for the LU10-___5 are:

North America	Europe
$V_{max} = 32 \text{ VDC}$	$U_i = 32 \text{ VDC}$
$I_{max} = 0.5 \text{ A}$	$I_i = 0.5 \text{ A}$
$P_{max} = 1.3 \text{ W}$	$P_i = 1.3 \text{ W}$
$C_i = 0 \mu\text{F}$	$C_i = 0 \mu\text{F}$
$L_i = 0 \mu\text{H}$	$L_i = 0 \mu\text{H}$

Intrinsically Safe Control Drawing:

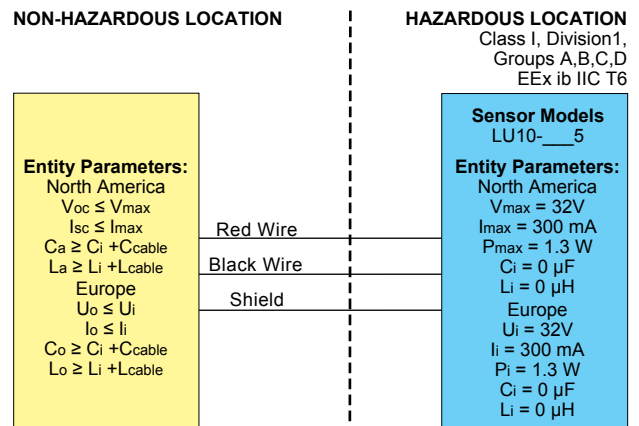

Sensor Drawing: U10900
Sheet 1 of 2
Rev. B 4-02-01

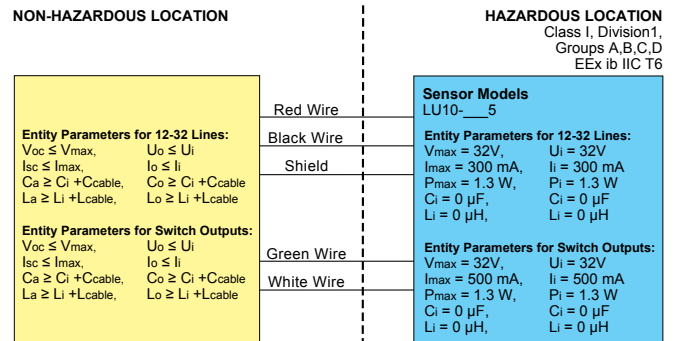

Notes: PARAMETERS DEPEND ON OUTPUT TYPE
1. Installation should be in accordance with CEC Part 1, or NFPA 70.
2. Associated Equipment shall be CSA certified with entity parameters connected in accordance with manufacturers instructions.

Sensor Drawing: U10900
Sheet 2 of 2
Rev. B 4-02-01

WIRING

Step Eleven

Wiring as a P-Channel or N-Channel output:

The Switch-Tek™ can be substituted for either a P-Channel (PNP, sourcing) output or a N-Channel (NPN, sinking) output.

Normally Open DC Load as a P-Channel Output:

To wire as a NO P-Channel output, follow the directions below. The Red wire connects to Positive (+) of the power supply and the Black wire connects to Negative (-). The Green wire is jumpered to the Red wire while the White wire is connected to the LOAD. Jumper the LOAD back to the Negative (-) to complete the circuit.

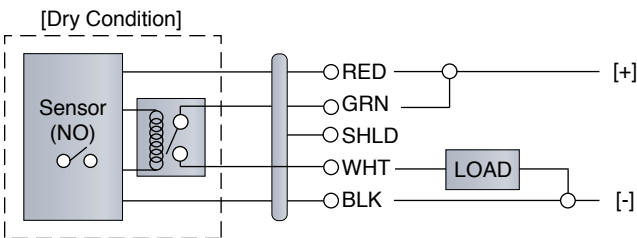

Normally Closed DC Load as a P-Channel Output:

To wire as a NC P-Channel output, follow the directions below. The Black wire connects to Positive (+) of the power supply and the Red wire connects to Negative (-). The Green wire is jumpered to the Black wire while the White wire is connected to the LOAD. Jumper the LOAD back to the Negative (-) to complete the circuit.

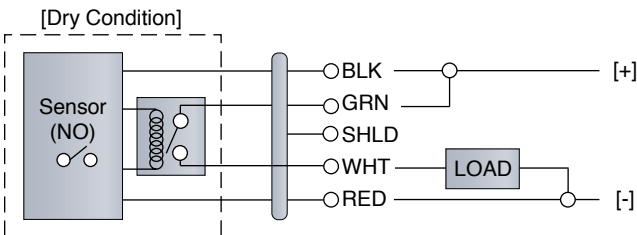

Normally Open DC Load as a N-Channel Output:

To wire as a NO N-Channel output, follow the directions below. The Red wire connects to Positive (+) of the power supply and the Black wire connects to Negative (-). The White wire is jumpered to the Black wire while the Green wire is connected to the LOAD. Jumper the LOAD back to the Positive (+) to complete the circuit.

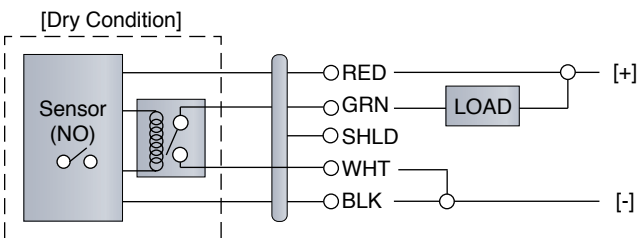

Normally Closed DC Load as a N-Channel Output:

To wire as a NC N-Channel output, follow the directions below. The Black wire connects to Positive (+) of the power supply and the Red wire connects to Negative (-). The White wire is jumpered to the Red wire while the White wire is connected to the LOAD. Jumper the LOAD back to the Positive (+) to complete the circuit.

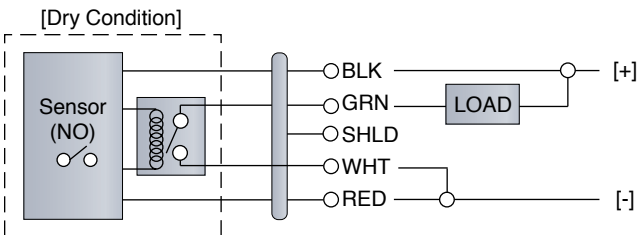

MAINTENANCE

Step Twelve

General:

The Switch-Tek™ level switch requires no periodic maintenance except cleaning as required. It is the responsibility of the user to determine the appropriate maintenance schedule, based on the specific characteristics of the application liquids.

Cleaning Procedure:

- 1. Power:** Make Sure that all power to the sensor, controller and/or power supply is completely disconnected.
- 2. Sensor Removal:** In all through-wall installations, make sure that the tank is drained well below the sensor prior to removal. Carefully, remove the sensor from the installation.
- 3. Cleaning the Sensor:** Use a soft bristle brush and mild detergent, carefully wash the Switch-Tek™ level switch. Do not use harsh abrasives such as steel wool or sandpaper, which might damage the surface sensor. Do not use incompatible solvents which may damage the sensor's PP, PFA, PVDF or Ryton plastic body.
- 4. Sensor Installation:** Follow the appropriate steps of installation as outlined in the installation section of this manual.

Testing the installation:

- 1. Power:** Turn on power to the controller and/or power supply.
- 2. Immersing the switch:** Immerse the sensing tip in its application liquid, by filling the tank up to the switches point of actuation. An alternate method of immersing the switch during preliminary testing is to hold a cup filled with application liquid up to the switch's tip.
- 3. Test:** With the switch being fluctuated between wet and dry states, the switch indicator light in the controller should turn on and off. If the controller doesn't have an input indicator, use a voltmeter or ammeter to ensure that the switch produces the correct signal.
- 4. Point of actuation:** Observe the point at which the rising or falling fluid level causes the switch to change state, and adjust the installation of the switch if necessary.

Maintenance Output to LED (LZ12 Only):

To wire the maintenance output wire to an LED, follow the wiring diagram below. The Yellow wire is connected to the LED and a 2.2kΩ resistor in series and referenced back to the (+) of the power supply.

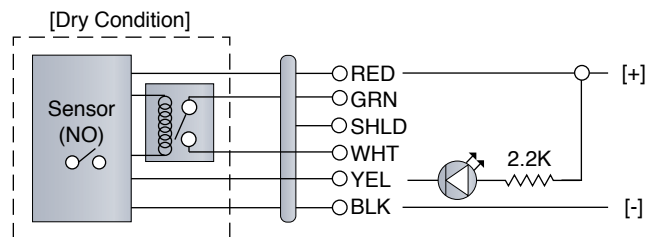

Maintenance Output to PLC (LZ12 Only):

To wire the maintenance output wire to an PLC, follow the wiring diagram below. The Yellow wire is connected to the PLC input with a 10 kΩ resistor parallel to the PLC input and the (+) of the power supply.

